



## Check list: Safety relays PNOZclassic – PNOZsigma

Application examples showing terminal comparisons for replacing safety relays from the PNOZclassic product range with PNOZsigma

**pilz**

# Why does Pilz offer more?



**Because the integrality of our business activities is what sets us apart.**



Pilz is a solution supplier for all automation functions. Including standard control functions. Developments from Pilz protect man, machine and the environment. That's why all our experience and knowledge goes into individual products as well as consistently sophisticated system solutions.

- ▶ Sensor technology
- ▶ Control technology
- ▶ Networks
- ▶ Drive technology
- ▶ Operator and visualisation systems
- ▶ Software
- ▶ Consulting and engineering
- ▶ Training

Appropriate services relating to individual components and independent generic services guarantee that our customers obtain customised automation solutions, all from one source.

**You can find more details about Pilz and your products and services on the Internet:**

- ▶ [www.pilz.com](http://www.pilz.com)

**Pilz is a family business that's closer to its customers**

Pilz has a tradition as a family-run company stretching back 60 years. Real proximity to customers is visible in all areas, instilling confidence through individual consultation, flexibility and reliable service.

We are your contact, guide and competency leader en route to an optimum automation solution.

**Support – Technical help round the clock!**

Technical support is available from Pilz round the clock. This service is provided free of charge beyond standard business hours.

**You can reach our international hotline on:**

- ▶ +49 711 3409-444

Exclusion of liability

Our application manual has been compiled with great care. It contains information about our company and our products. All statements are made in accordance with the current status of technology and to the best of our know-ledge and belief. However, we cannot except liability for the accuracy and entirety of the information provided, except in the case of gross negligence. In particular it should be noted that statements do not have the legal quality of assurances or assured properties. We are grateful for any feedback on the contents.

April 2009

All rights to this publication are reserved by Pilz GmbH & Co. KG. We reserve the right to amend specifications without prior notice. Copies may be made for the user's internal purposes. The names of products, goods and technologies used in this manual are trademarks of the respective companies.

## Solution supplier for safety and standard

Pilz offers a universal concept for solutions that can be applied right across industry. Whether you need safety or standard control functions, machine or plant, centralised or decentralised, a single product or a total solution: With Pilz you will definitely find a solution for your automation function.

### Are you looking for a flexible solution for your automation functions?

- ▶ **PMD:** Electronic monitoring relays such as voltage or true power monitors, for example.
- ▶ **PNOZ:** Safety relays for simple plant and machinery with up to 4 safety functions. Safe monitoring of E-STOPS, safety gates and light curtains/light grids, for example.
- ▶ **PNOZmulti:** The safety circuit is created using a simple configuration tool. Applicable from 4 safety functions.
- ▶ **PSS:** Programmable control systems for use on complex machinery or distributed plants, to monitor safety-related functions and/or for complete machine control.
- ▶ **Industrial communication:** Transfer input/output signals and control data reliably and safely.

Your requirements:	Our solution:	Supplementary product ranges:
	<p><i>PMD electronic monitoring relays</i></p>	<p><i>Sensor technology</i></p>
	<p><i>PNOZ safety relays</i></p>	<p><i>Drive technology</i></p>
	<p><i>PNOZmulti configurable control system</i></p>	<p><i>Operator and visualisation systems</i></p>
	<p><i>PSS programmable control systems</i></p>	<p><i>Software</i></p>
	<p><i>SafetyBUS p</i> <i>induraNET p</i></p> <p><i>SafetyNET p</i></p> <p><i>Industrial communication networks</i></p>	<p><i>Services</i></p>

**Sensor technology**, used in conjunction with Pilz safe control technology, offers a coordinated, complete solution that's economical, approved and safe. The focus is always on the protection of man and machine, in compliance with the standards and regulations.

**Drive technology** provides overall solutions for automating your machinery. From controller operation through to movement of highly dynamic drives, including all safety aspects.

**Operator and visualisation systems** provide diagnostic and visualisation devices, plus control and signal devices as part of the Pilz solution. The focus is always on fast, simple configuration. Machine downtimes are clearly reduced thanks to the overall diagnostic concept PVIS.

**Software includes system software**, user software and software tools. Here you'll find the right tool for every task. From product-related software to diagnostic software, through to the PAScal Safety Calculator.

**Services** in the field of machinery safety are covered holistically by Pilz. From risk assessment through to ESPE inspection. Pilz also offers a comprehensive range of training courses and seminars, covering generic issues relating to machinery safety as well as Pilz products.

Check list: PNOZclassic – PNOZsigma	1.0
Comparison chart	1.1
Application examples with terminal comparison	2.0
Application examples	2.1
Service	3.0
Technical offices in Germany	3.1

---

<b>Content</b>	<b>Page</b>
<b>Check list: Safety relays PNOZclassic – PNOZsigma</b>	
Comparison chart	1.1-2

## Comparison chart

On 31. December 2010 the PNOZclassic-range will be discontinued for reasons of availability of spare parts and the technical progress. PNOZclassic devices may be replaced by the latest generation of PNOZsigma safety relays. PNOZsigma provides maximum functionality in minimum width. Online information on PNOZsigma is available from [www.pilz.com](http://www.pilz.com), webcode 0994.

The following list is a recommendation of replacement types from the PNOZsigma-range for discontinued types from the PNOZclassic-range. It is necessary to check and ensure that the listed replacement types suit the application, and that they can be used. We are happy to advise you on an alternative solution for your application:  
 Technical Support Tel.: +49 711 3409-444  
 E-Mail: [techsupport@pilz.de](mailto:techsupport@pilz.de)

<b>PNOZclassic Discontinued type</b>	<b>Supply voltage</b>	<b>Replacement type PNOZsigma</b>	<b>+ Required expansion device PNOZsigma</b>
N2HS	48 - 240 V AC	PNOZ s6 AC	
P1H-1SK	48 - 240 V AC	PNOZ s6 AC	
P1H-1SK	24 V DC	PNOZ s6	
P1HZ 1	48 - 240 V AC	PNOZ s6.1 AC	
P1HZ 1	24 V DC	PNOZ s6.1	
P1HZ 2	48 - 240 V AC	PNOZ s6.1 AC	
P1HZ 2	24 V DC	PNOZ s6.1	
P2HZ 5	24 V DC	PNOZ s6	
P2HZ 5	48 - 240 V DC	PNOZ s6 AC	
P2HZ 6	24 V DC	PNOZ s6 AC	
P2HZ 6	110 V AC	PNOZ s6 AC	
P2HZ 6	230 V AC	PNOZ s6 AC	
PNOZ 1	48 - 240 V AC	PNOZ s4 AC	
PNOZ 1	24 V DC	PNOZ s4	
PNOZ 1-2	48 - 230 V AC	PNOZ s4.1 AC	
PNOZ 1-2	24 V DC	PNOZ s4.1	
PNOZ 2	48 -240 V DC	PNOZ s4 AC	
PNOZ 3	24 V DC	PNOZ s4	PNOZ s7 or PNOZ s9
PNOZ 3	48 - 240 V AC	PNOZ s4 AC	PNOZ s7 or PNOZ s9
PNOZ 4	24 V DC	PNOZ s4	
PNOZ 5	48 - 240 V AC	PNOZ s4 AC	
PNOZ 5	24 V DC	PNOZ s1	
PNOZ 6	48 V AC	PNOZ s4	PNOZ s9
PNOZ 6	24 V DC	PNOZ s4	PNOZ s9
PNOZ 8	24 V DC	PNOZ s4	
PNOZ 8	48 - 240 V AC	PNOZ s4 AC	
PNOZ 9	24 V DC	PNOZ s1	
PNOZ 9	48 - 240 V AC	PNOZ s4 AC	
PNOZ V (3s)	24 V DC	PNOZ s5	
PNOZ V (30 s)	24 V DC	PNOZ s5	
PNOZ V (300 s)	24 V DC	PNOZ s5	

## Comparison chart

<b>PNOZclassic Discontinued type</b>	<b>Supply voltage</b>	<b>Replacement type PNOZsigma</b>	<b>+ Required expansion device PNOZsigma</b>
PST 1	48 - 230 V AC	PNOZ s4 AC	
PST 1	24 V DC	PNOZ s3	
PST 3	24 V DC	PNOZ s4	
PST 3	48 - 230 V AC	PNOZ s4 AC	

<b>Content</b>	<b>Page</b>
<b>Application examples with terminal comparison</b>	
N2HS (48 - 240 V AC) – PNOZ s6	2.1-2
P1H-1SK (48 - 240 V AC; 24 V DC – PNOZ s6	2.1-3
P1HZ 1 (48 - 240 V AC; 24 V DC) – PNOZ s6.1	2.1-4
P1HZ 2 (48 - 240 V AC; 24 V DC) – PNOZ s6.1	2.1-5
P2HZ 5 (24 V DC; 48 - 240 V DC) – PNOZ s6	2.1-6
P2HZ 6 (24 V DC; 110 V AC; 230 V AC) – PNOZ s6	2.1-7
PNOZ 1 (48 - 240 V AC; 24 V DC) – PNOZ s4	2.1-8
PNOZ 1-2 (48 - 230 V AC; 24 V DC) – PNOZ s4.1	2.1-9
PNOZ 2 (48 - 240 V DC) – PNOZ s4	2.1-10
PNOZ 3 (24 V DC; 48 - 240 V AC) – PNOZ s4 and expander module PNOZ s7	2.1-11
PNOZ 4 (24 V DC) – PNOZ s4	2.1-12
PNOZ 5 (48 - 240 V AC) – PNOZ s4	2.1-13
PNOZ 5 (24 V DC) – PNOZ s1	2.1-14
PNOZ 6 (48 V AC; 24 V DC) – PNOZ s4 and expander module PNOZ s9	2.1-15
PNOZ 8 (24 V DC; 48 - 240 V AC) – PNOZ s4	2.1-17
PNOZ 9 (24 V DC) – PNOZ s1	2.1-18
PNOZ 9 (48 - 240 V AC) – PNOZ s4	2.1-19
PNOZ V (24 V DC) – PNOZ s5	2.1-20
PST 1 (48 - 230 V AC) – PNOZ s4	2.1-21
PST 1 (24 V DC) – PNOZ s3	2.1-22
PST 3 (24 V DC; 48 -230 V AC) – PNOZ s4	2.1-23



## N2HS (48 - 240 V AC) – PNOZ s6

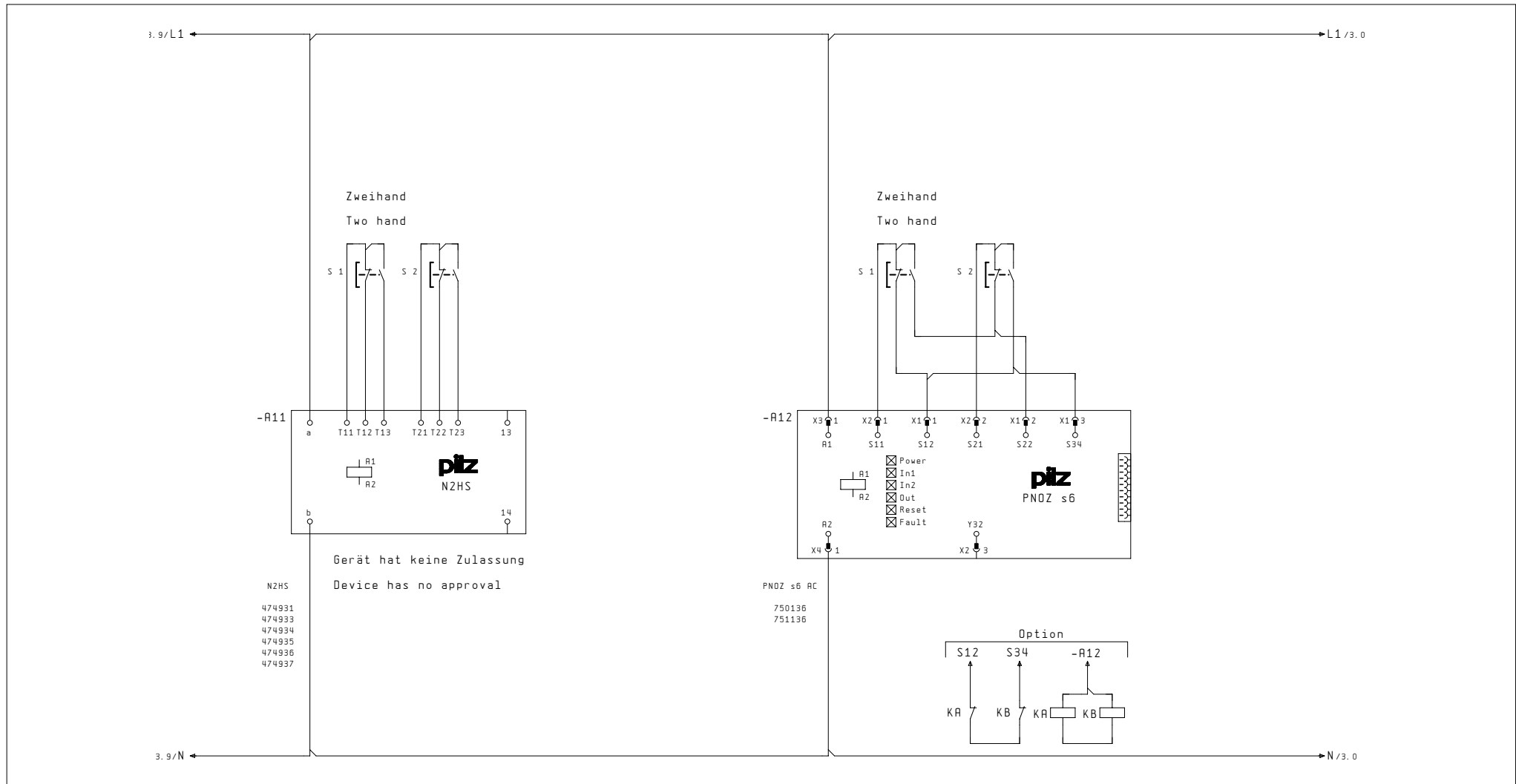

## P1H-1SK (48 - 240 V AC; 24 V DC) – PNOZ s6

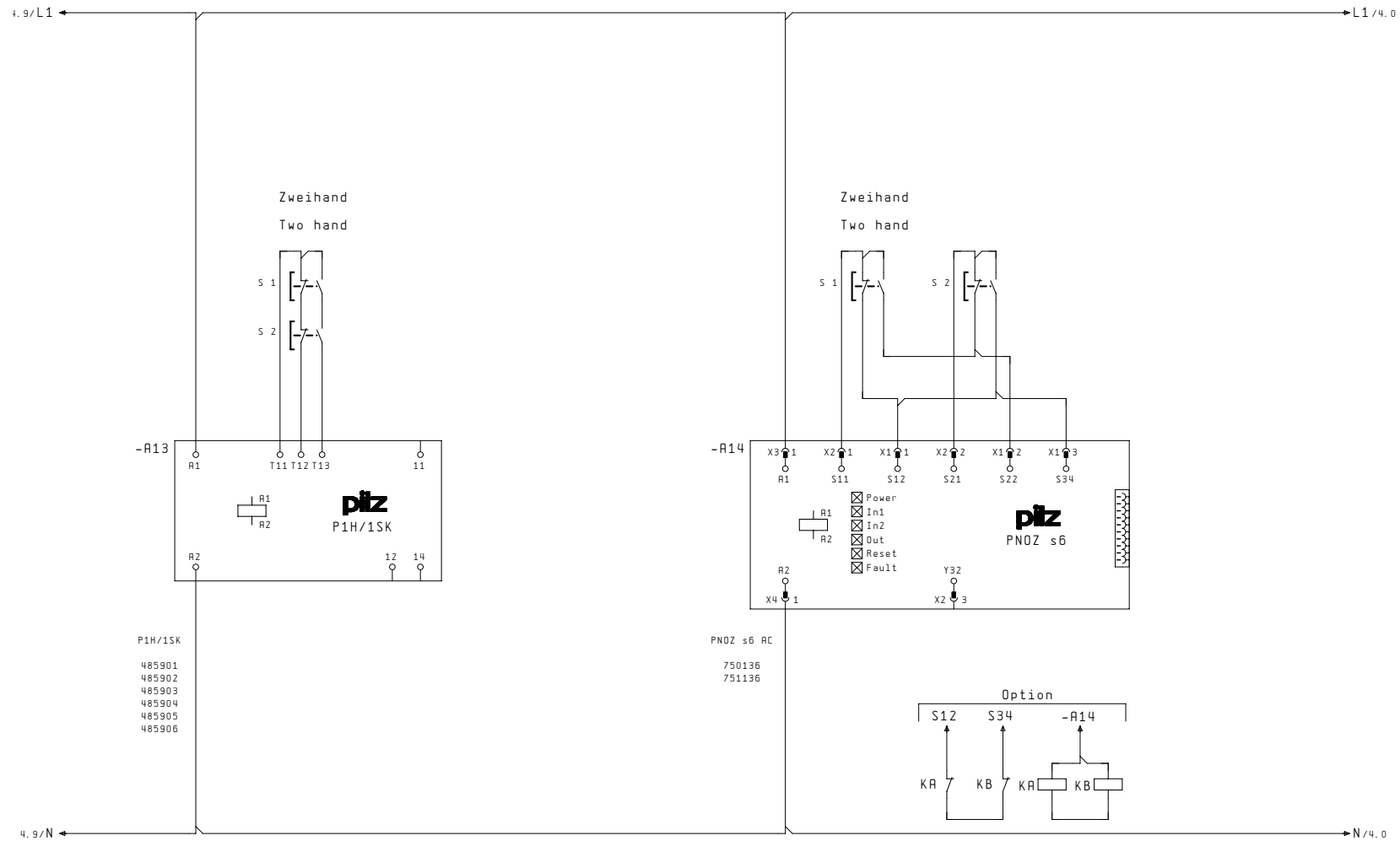

## P1HZ 1 (48 - 240 V AC; 24 V DC) – PNOZ s6.1

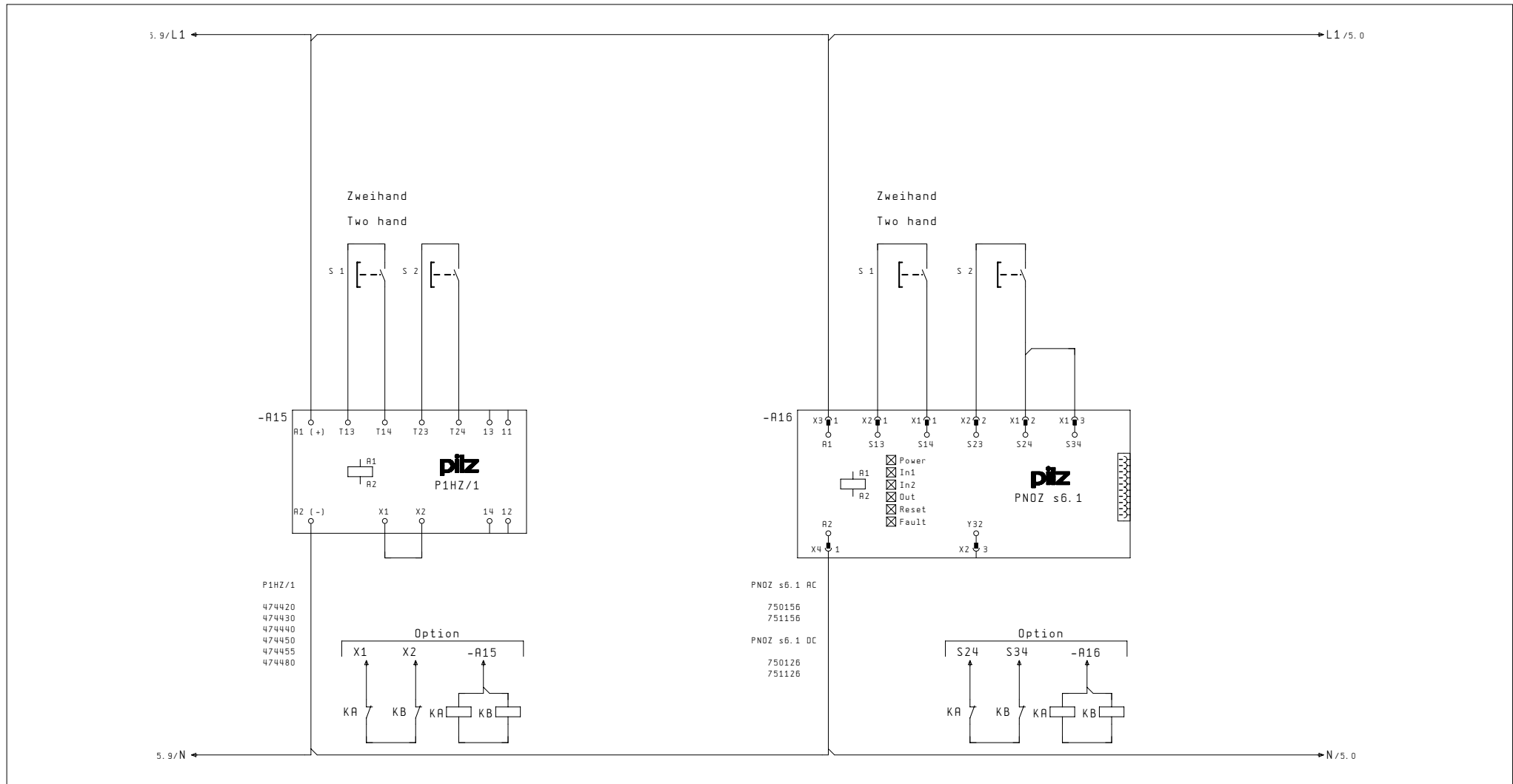

## P1HZ 2 (48 - 240 V AC; 24 V DC) – PNOZ s6.1

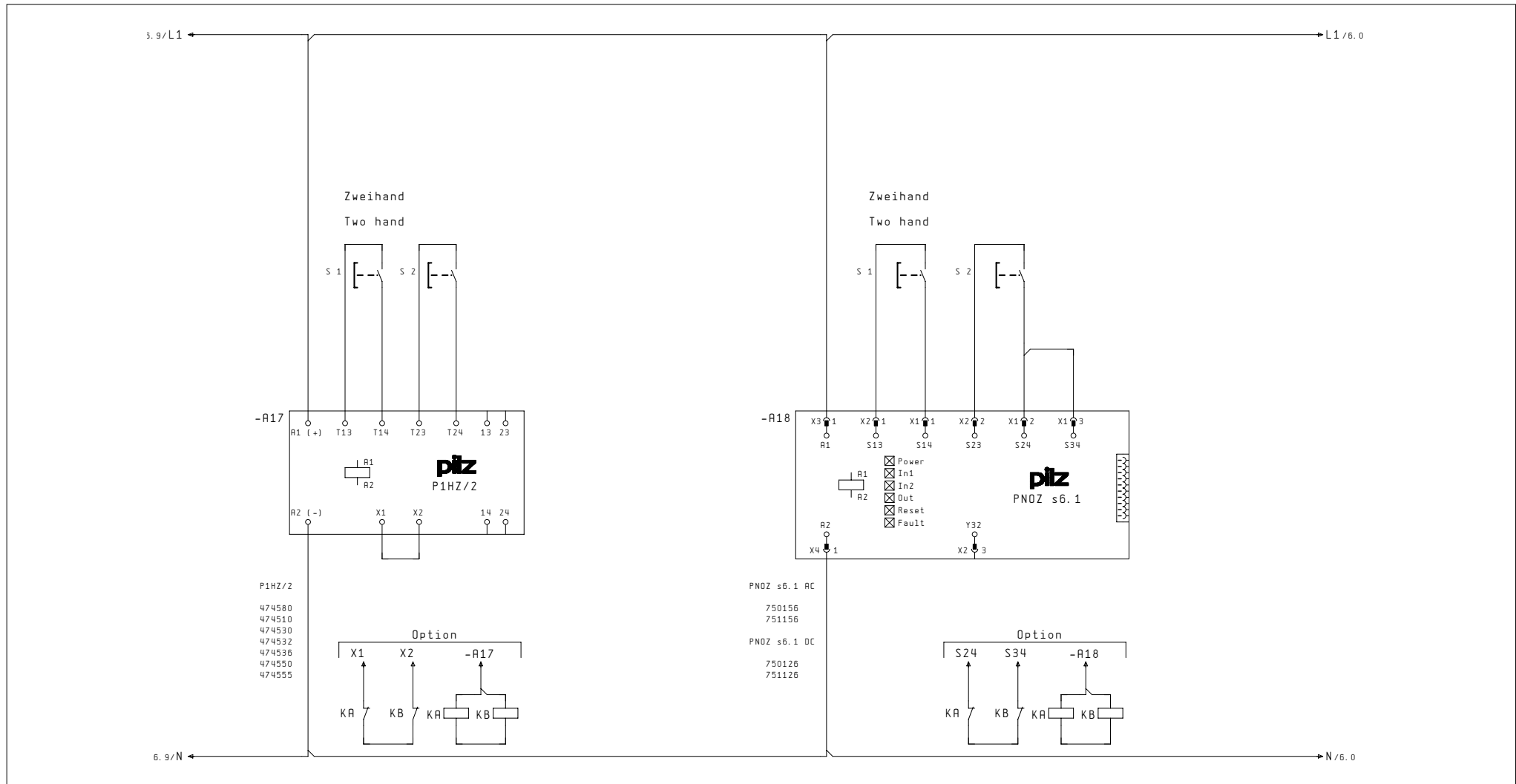

## P2HZ 5 (24 V DC; 48 - 240 V DC) – PNOZ s6

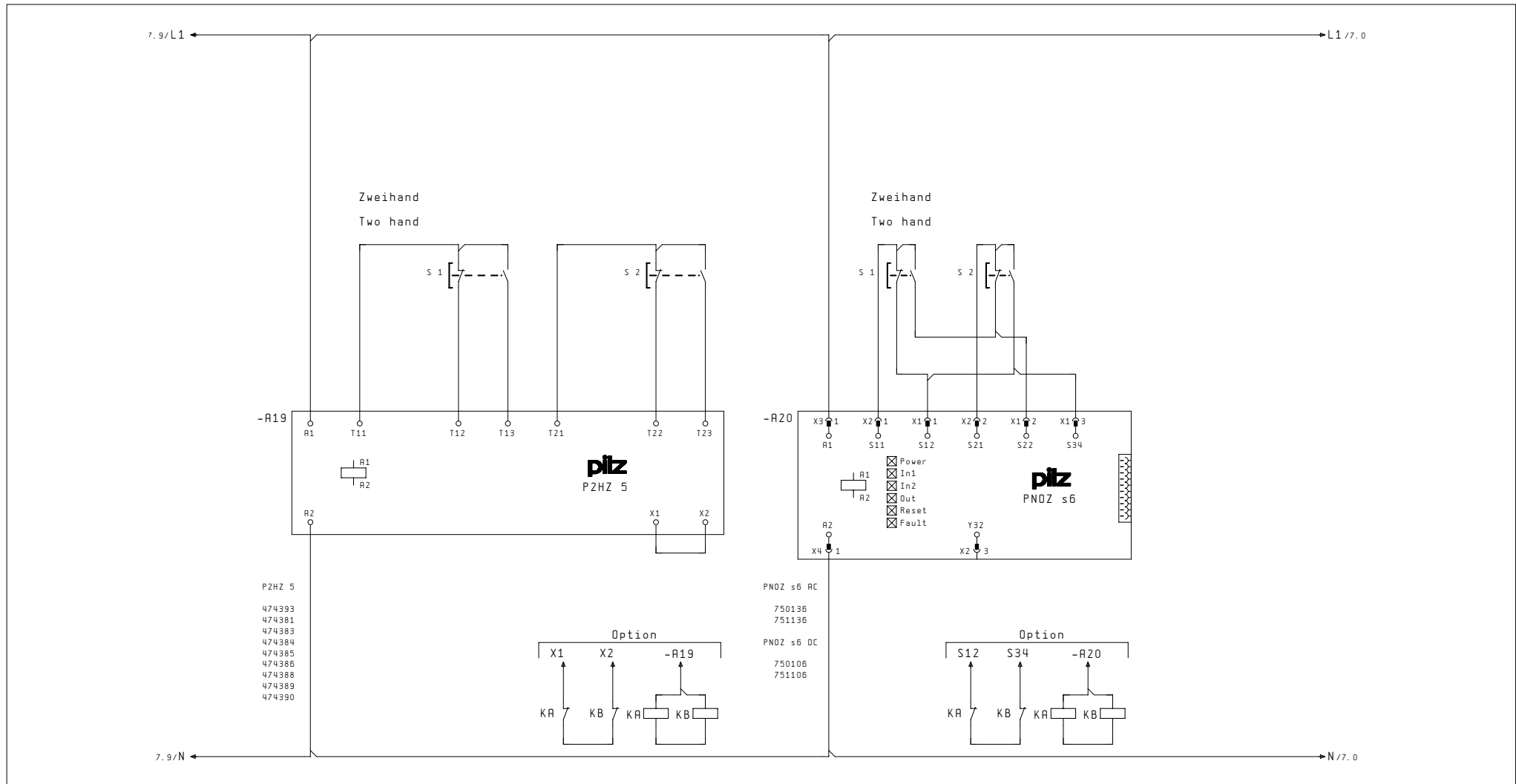

## P2HZ 6 (24 V DC; 110 V AC; 230 V AC) – PNOZ s6

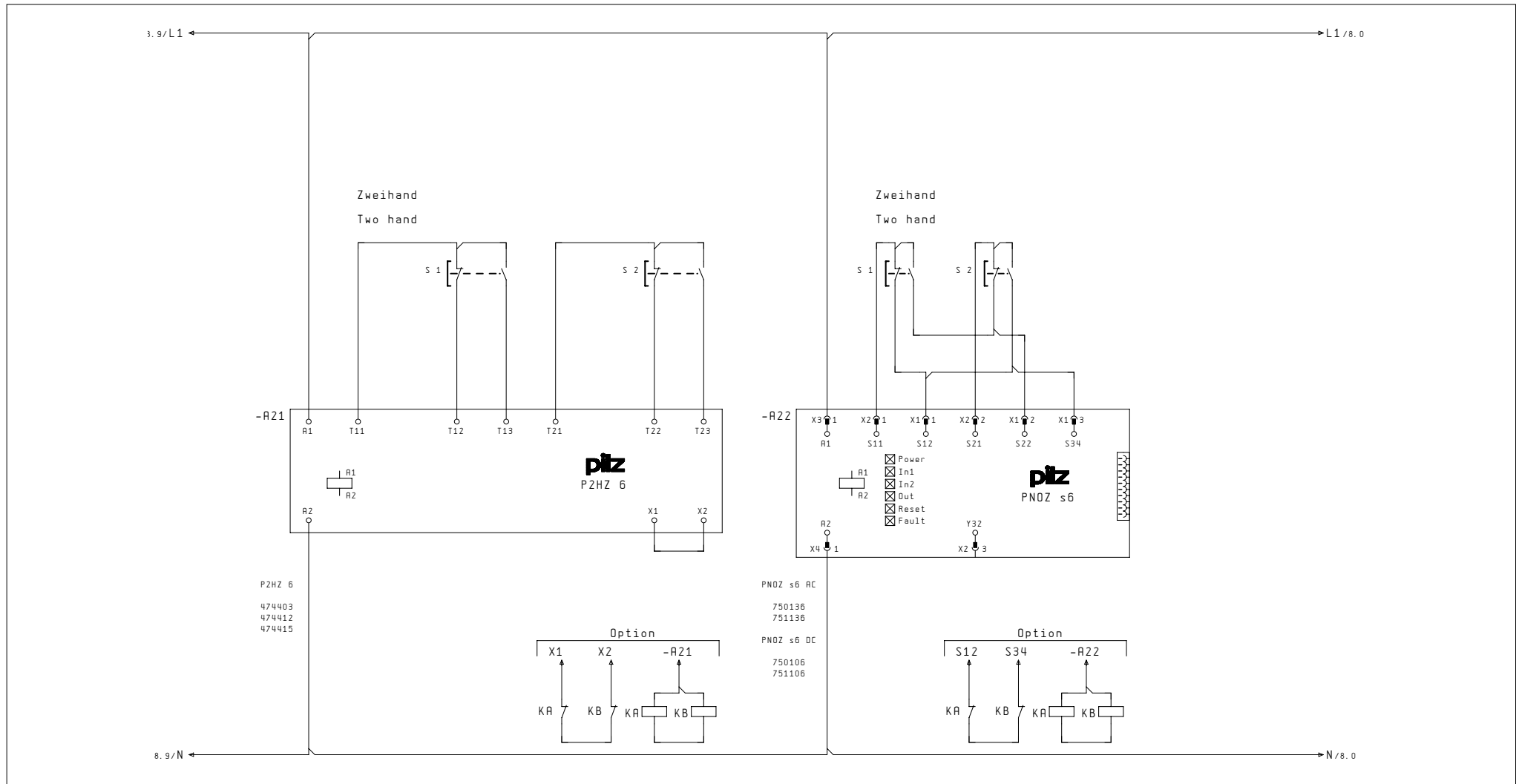

## PNOZ 1 (48 - 240 V AC; 24 V DC) – PNOZ s4

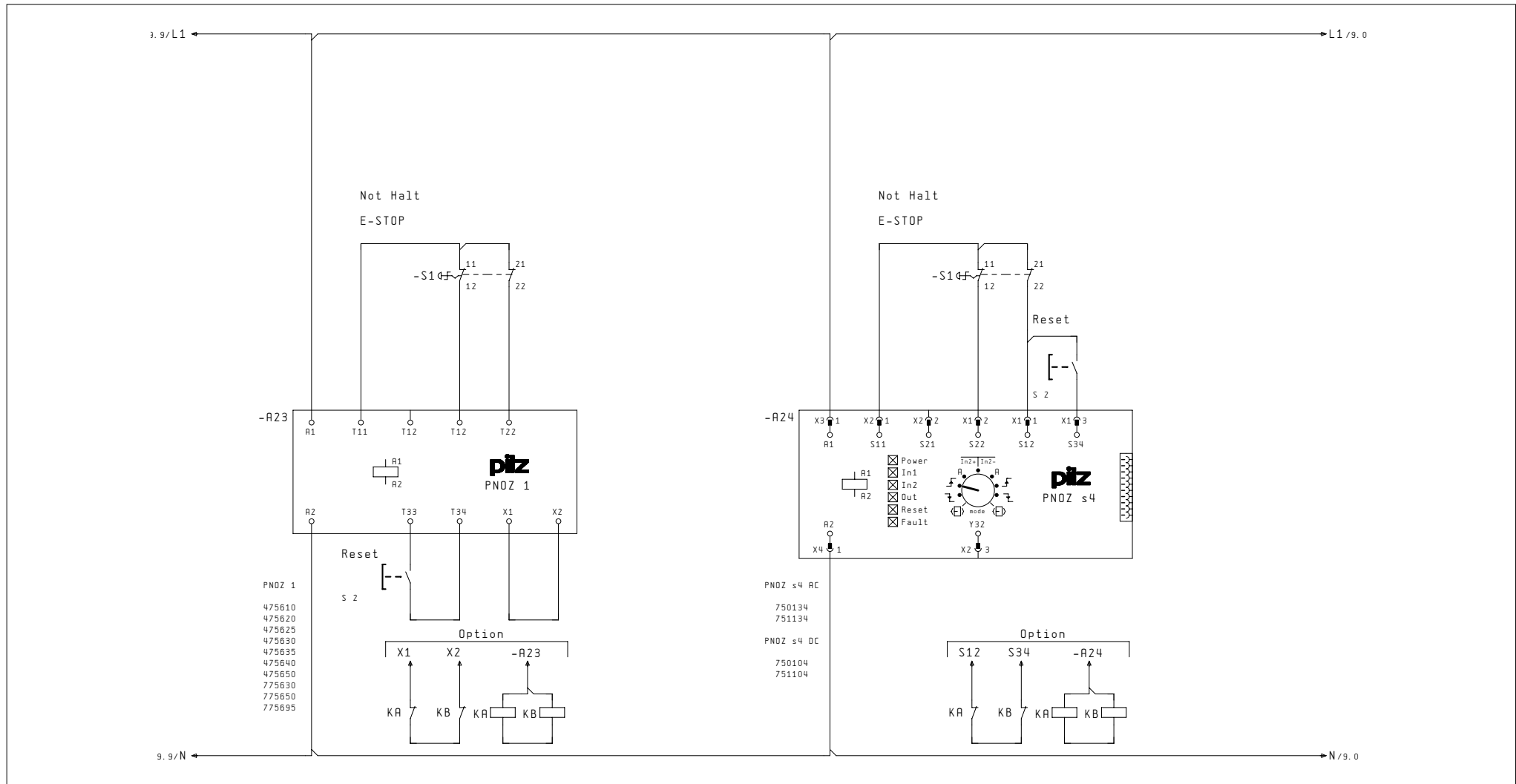

## PNOZ 1-2 (48 - 230 V AC; 24 V DC) – PNOZ s4.1

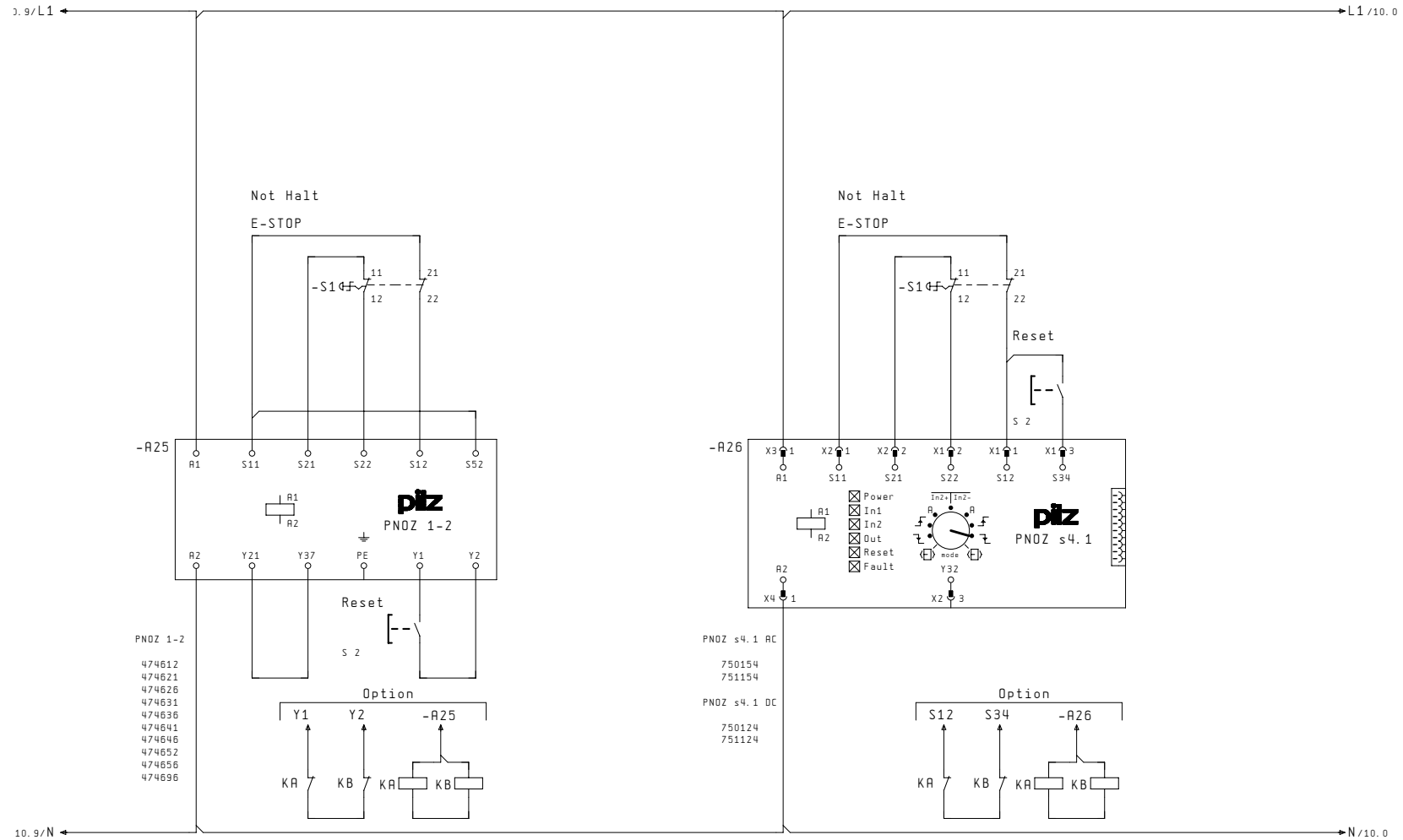



## PNOZ 2 (48 - 240 V DC) – PNOZ s4

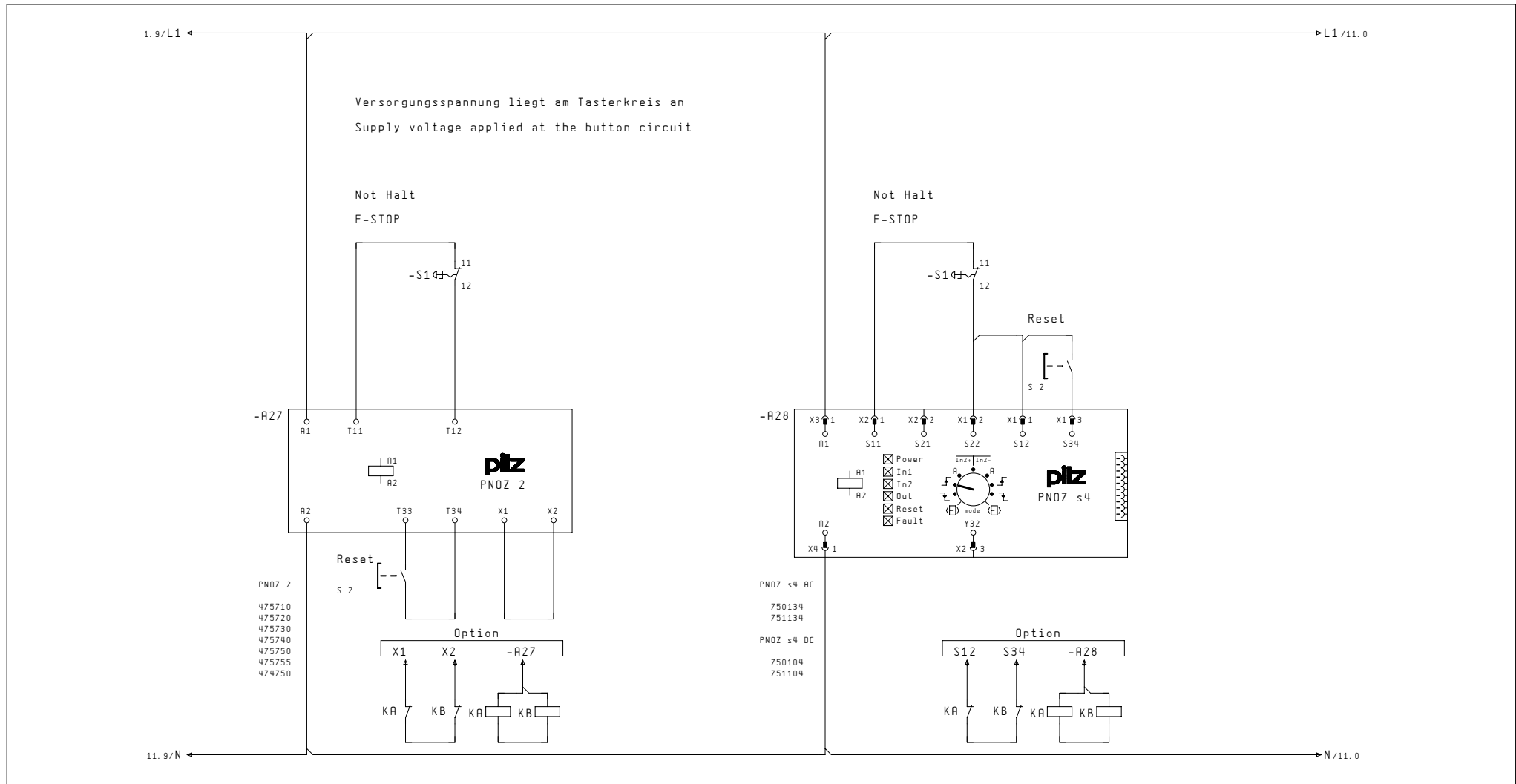

## PNOZ 3 (24 V DC; 48 - 240 V AC) – PNOZ s4 and expander module PNOZ s7

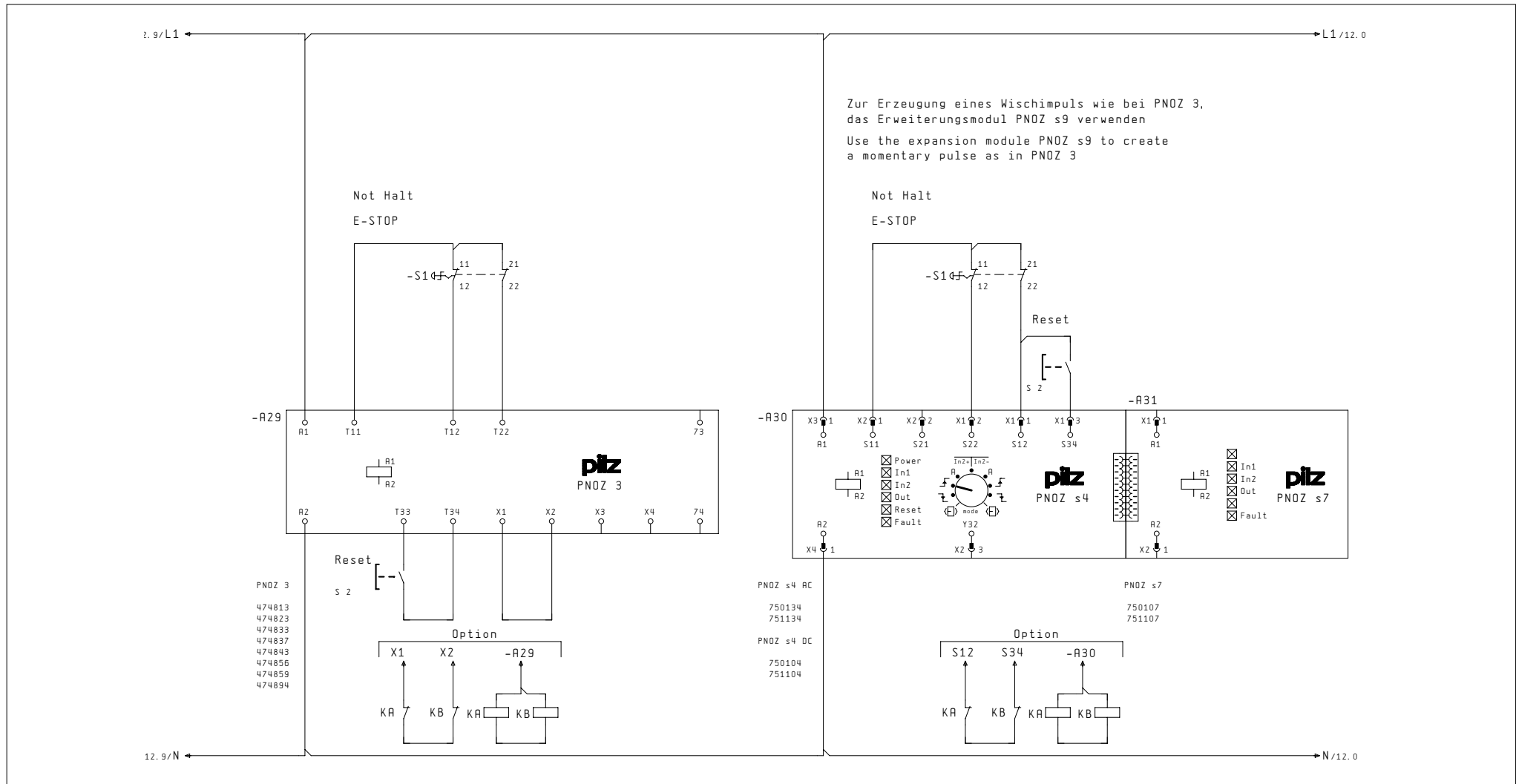

## PNOZ 4 (24 V DC) – PNOZ s4

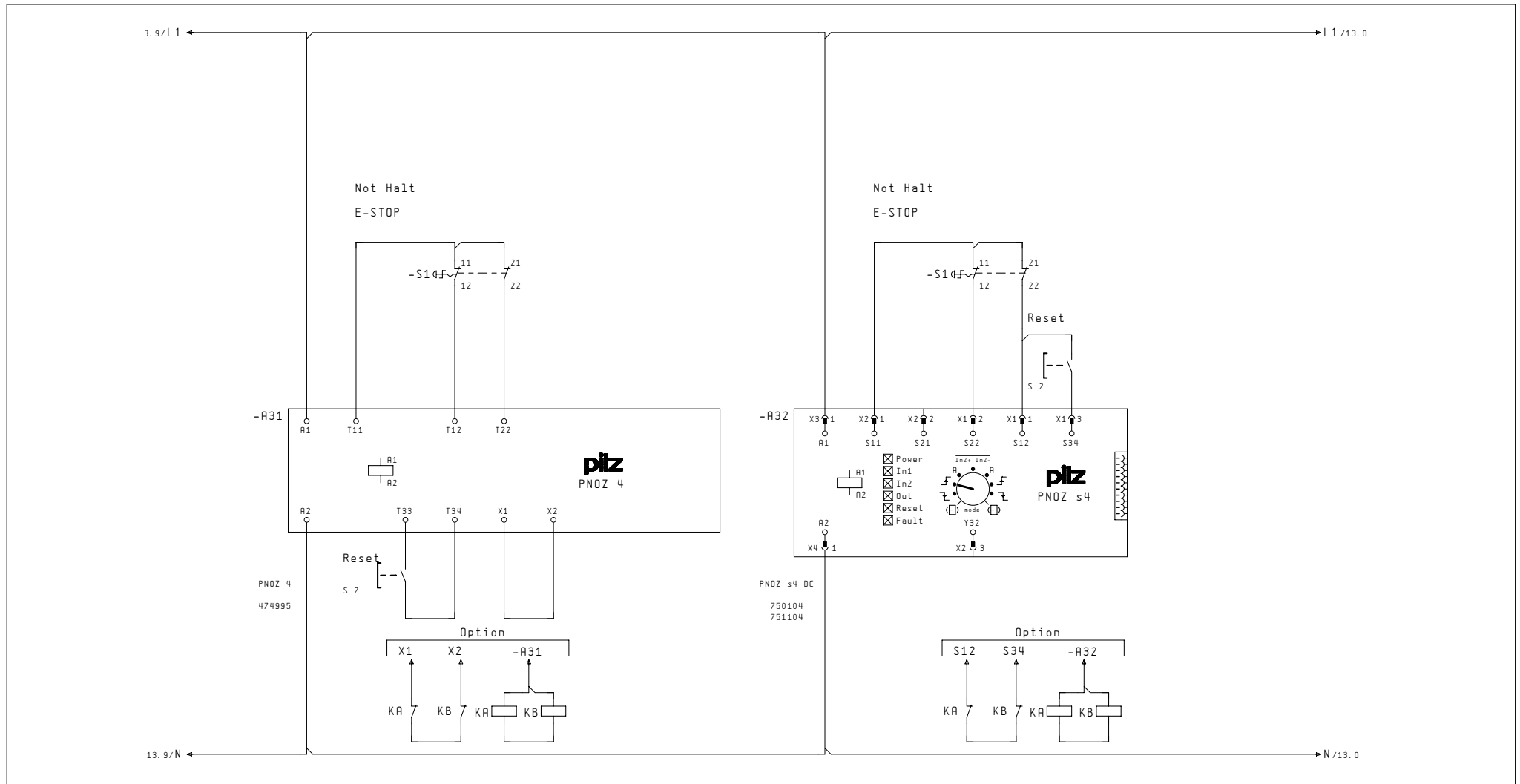

## PNOZ 5 (48 - 240 V AC) – PNOZ s4

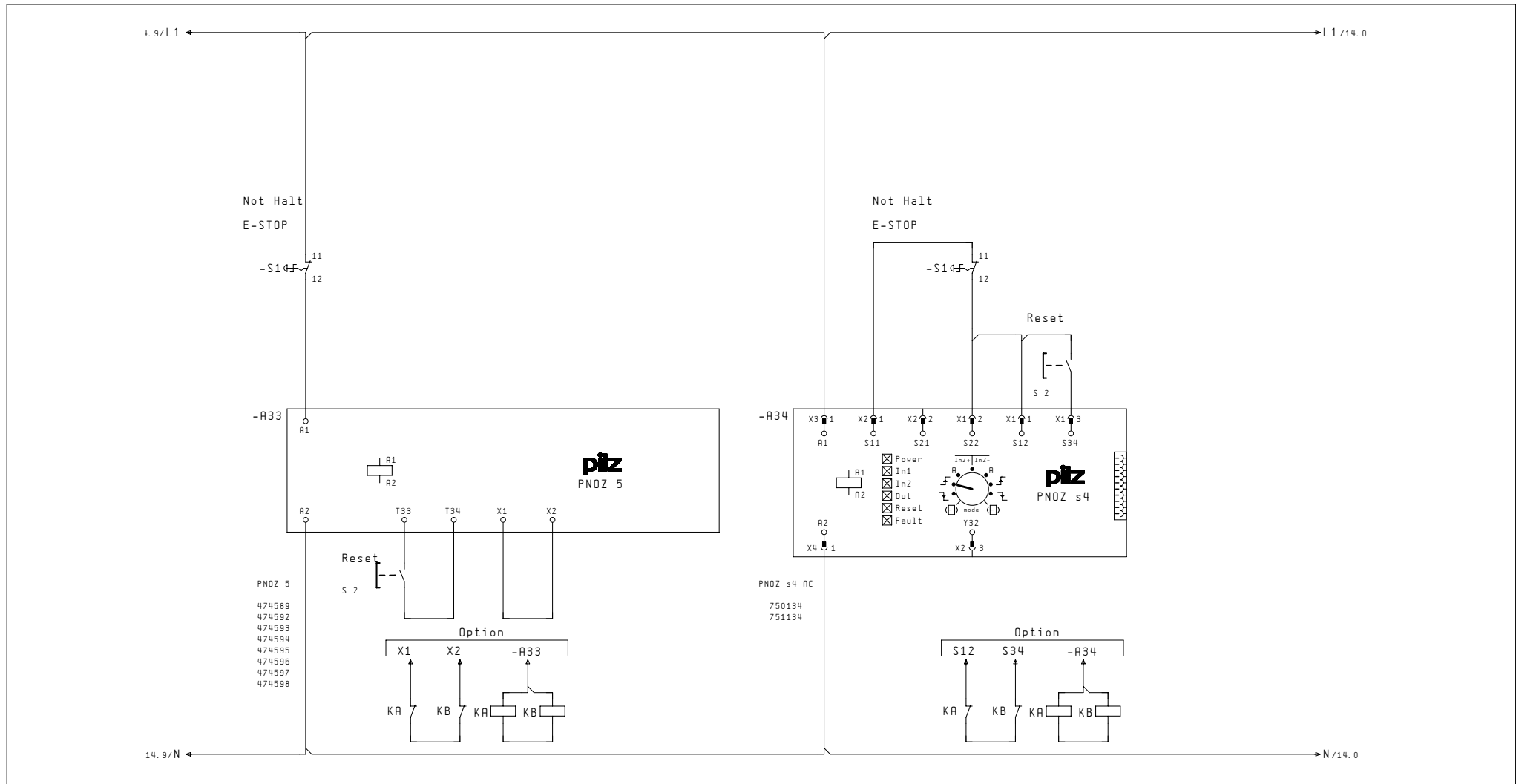

## PNOZ 5 (24 V DC) – PNOZ s1

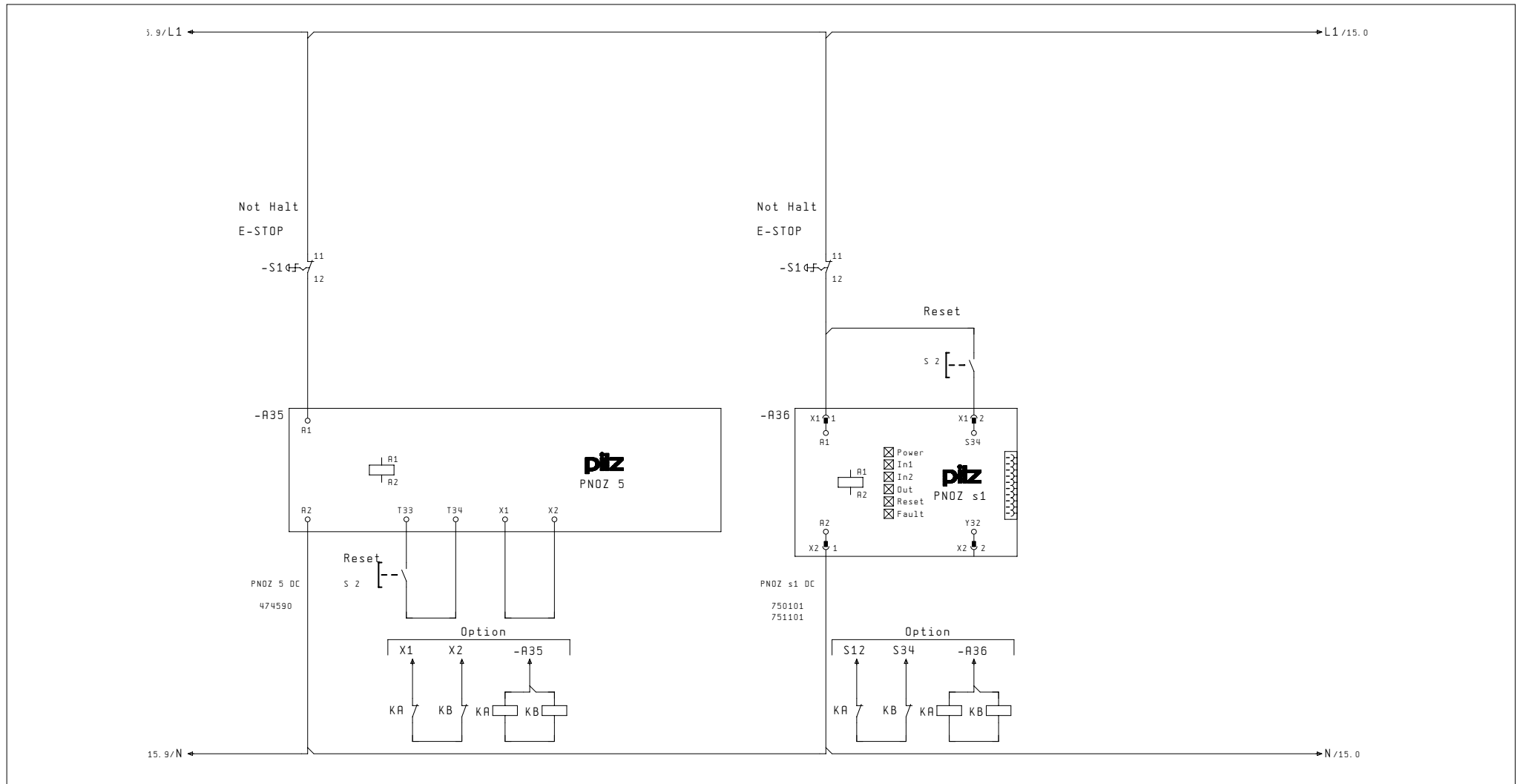

## PNOZ 6 (48 V AC; 24 V DC) – PNOZ s4 and expander module PNOZ s9

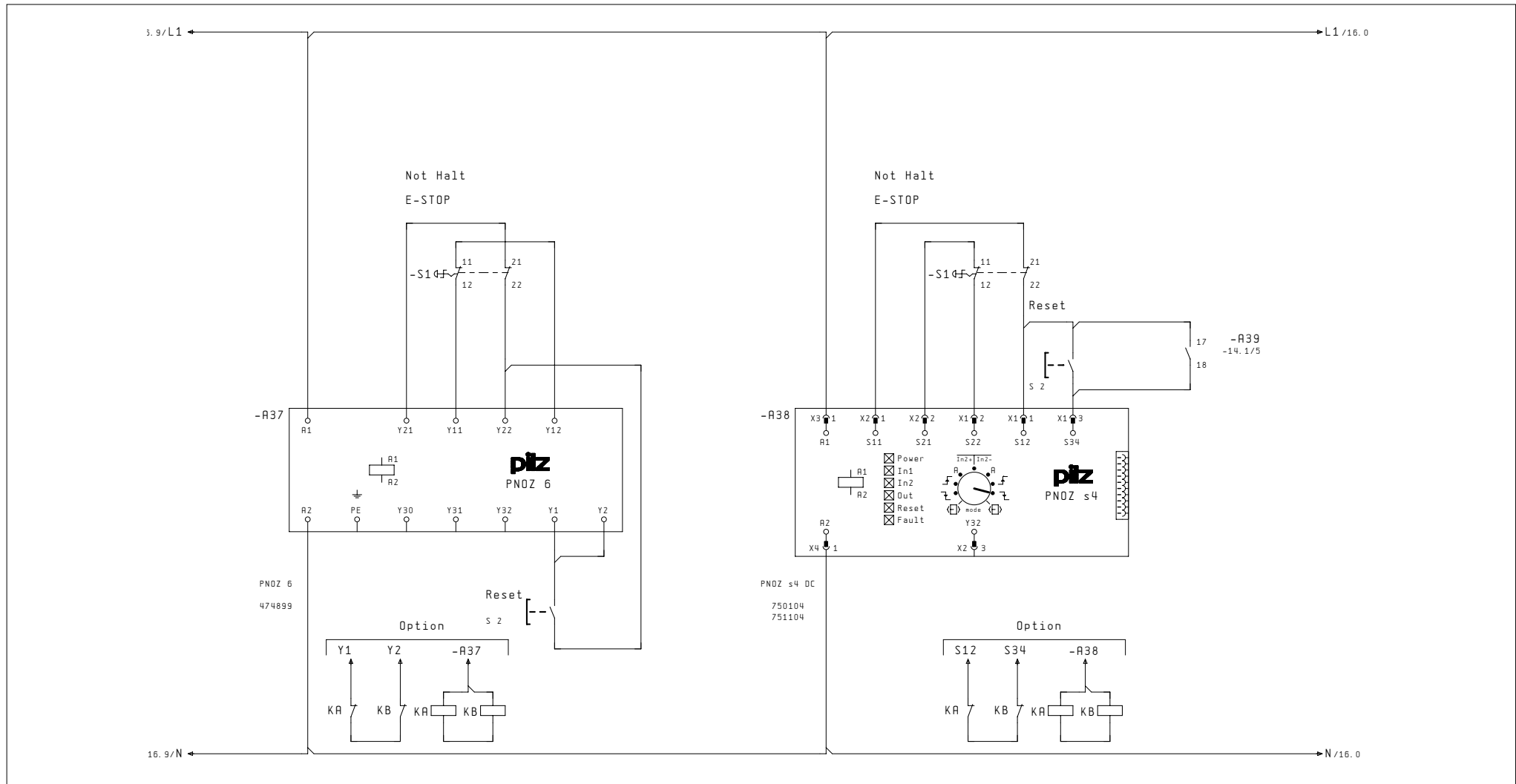

## PNOZ 6 (48 V AC; 24 V DC) – PNOZ s4 and expander module PNOZ s9

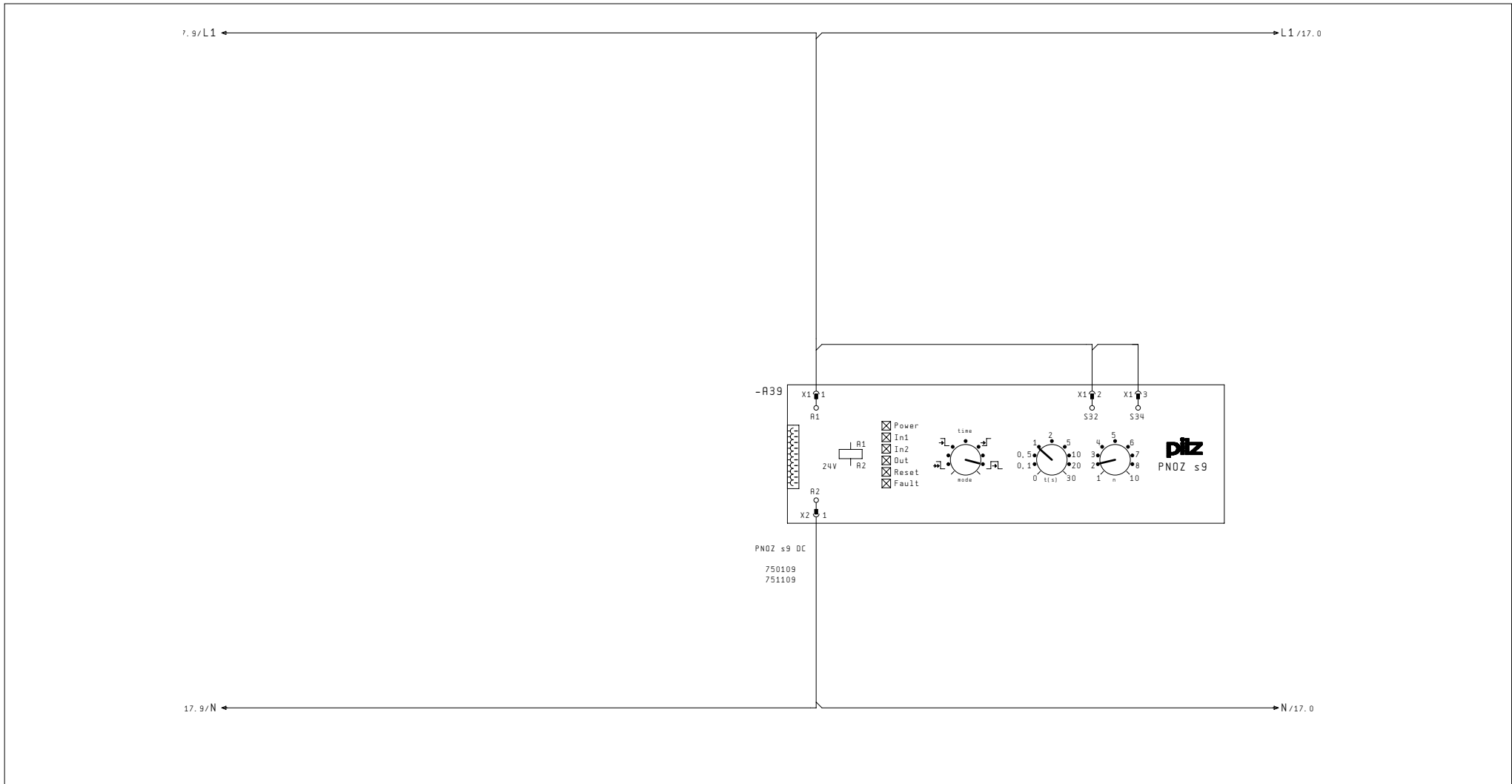

2.1

## PNOZ 8 (24 V DC; 48 - 240 V AC) – PNOZ s4

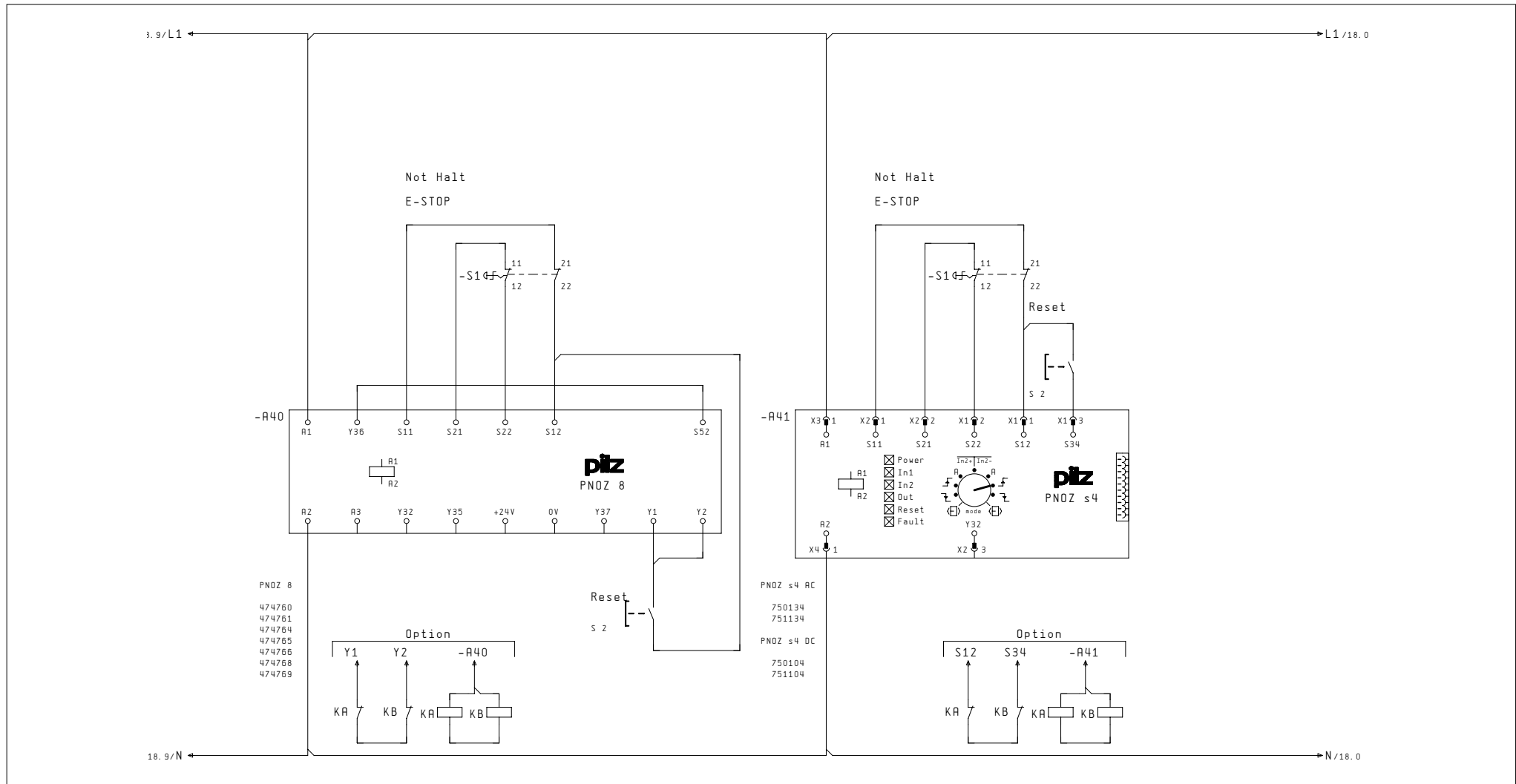



## PNOZ 9 (24 V DC) – PNOZ s1

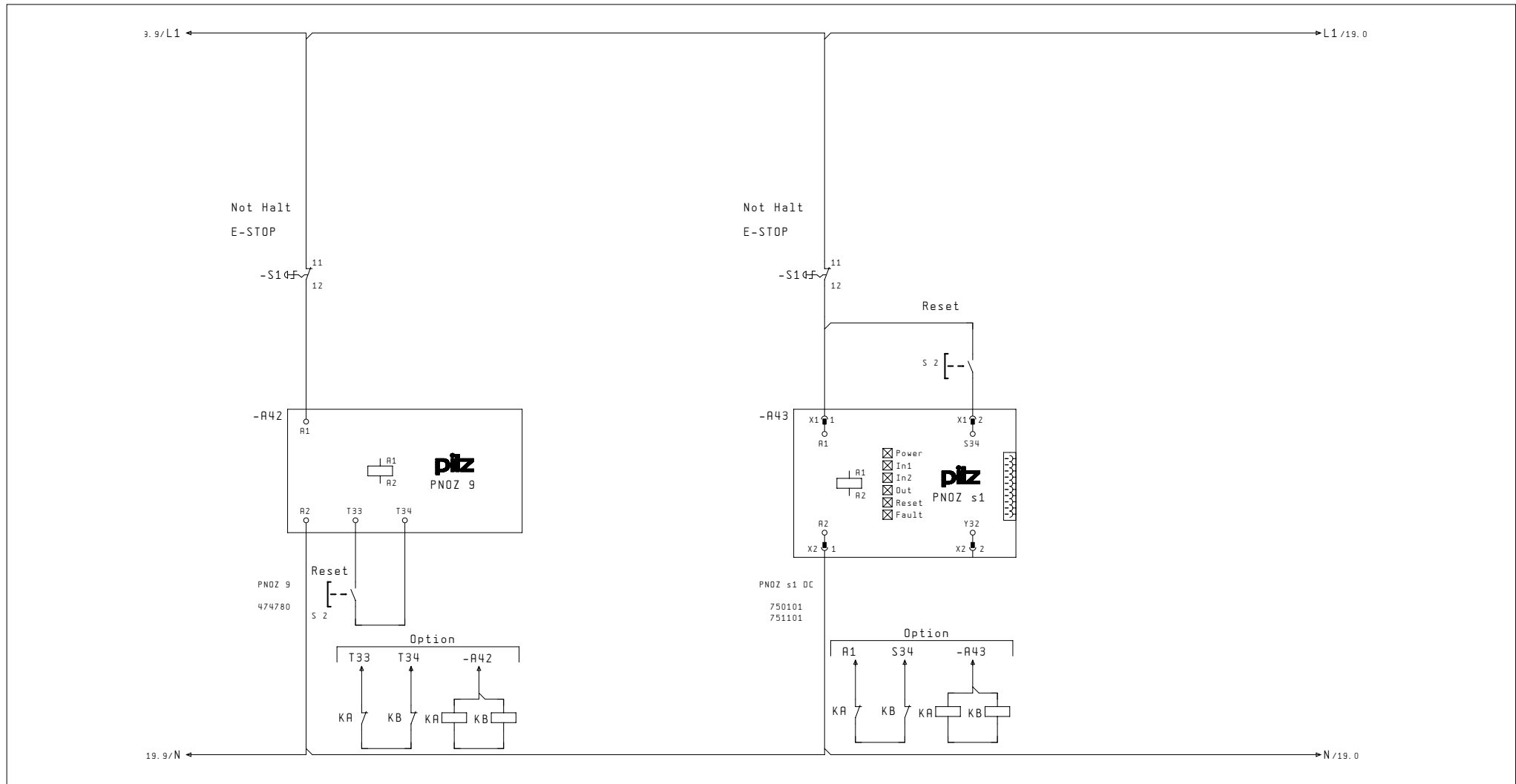

## PNOZ 9 (48 - 240 V AC) – PNOZ s4

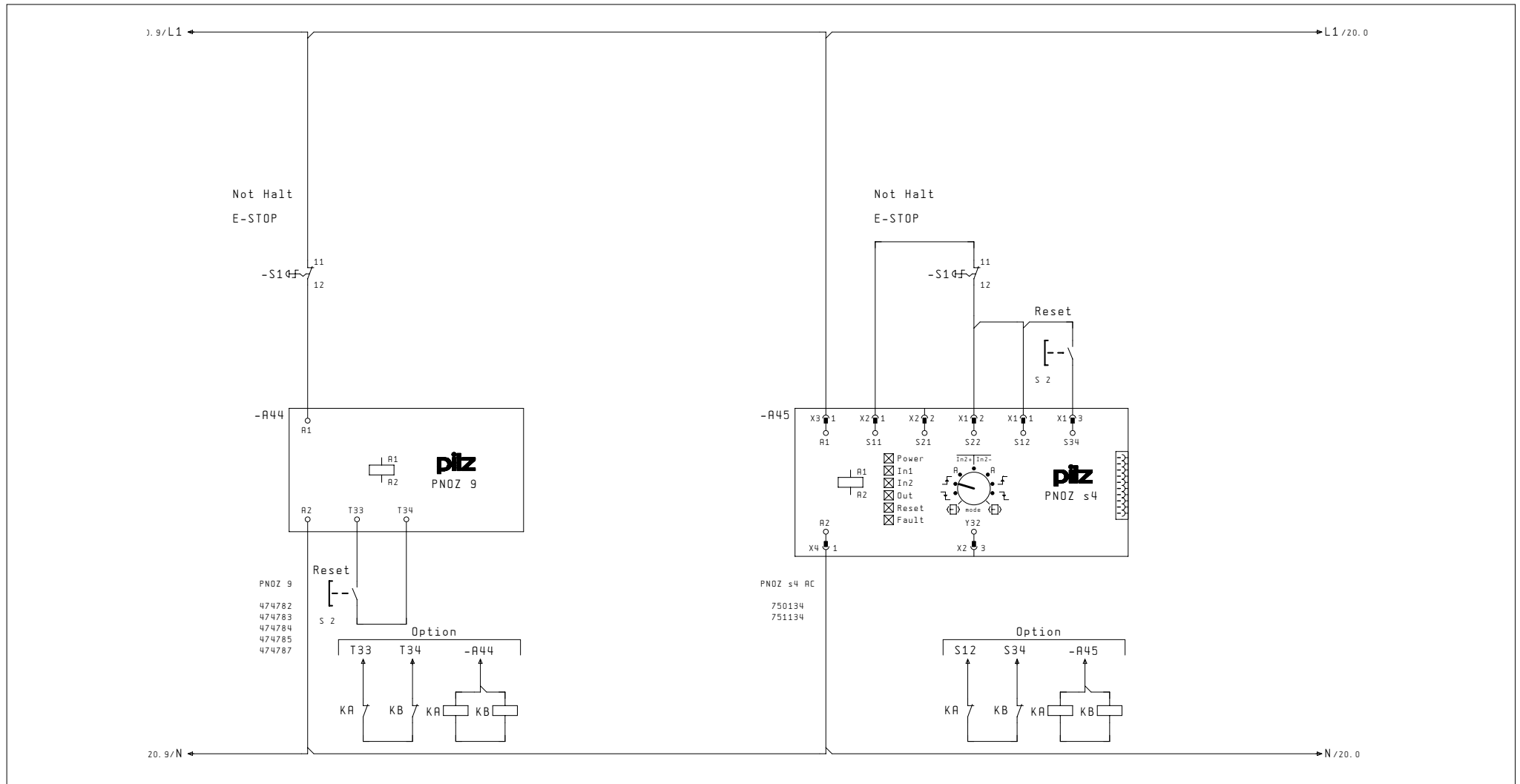

## PNOZ V (24 V DC) – PNOZ s5

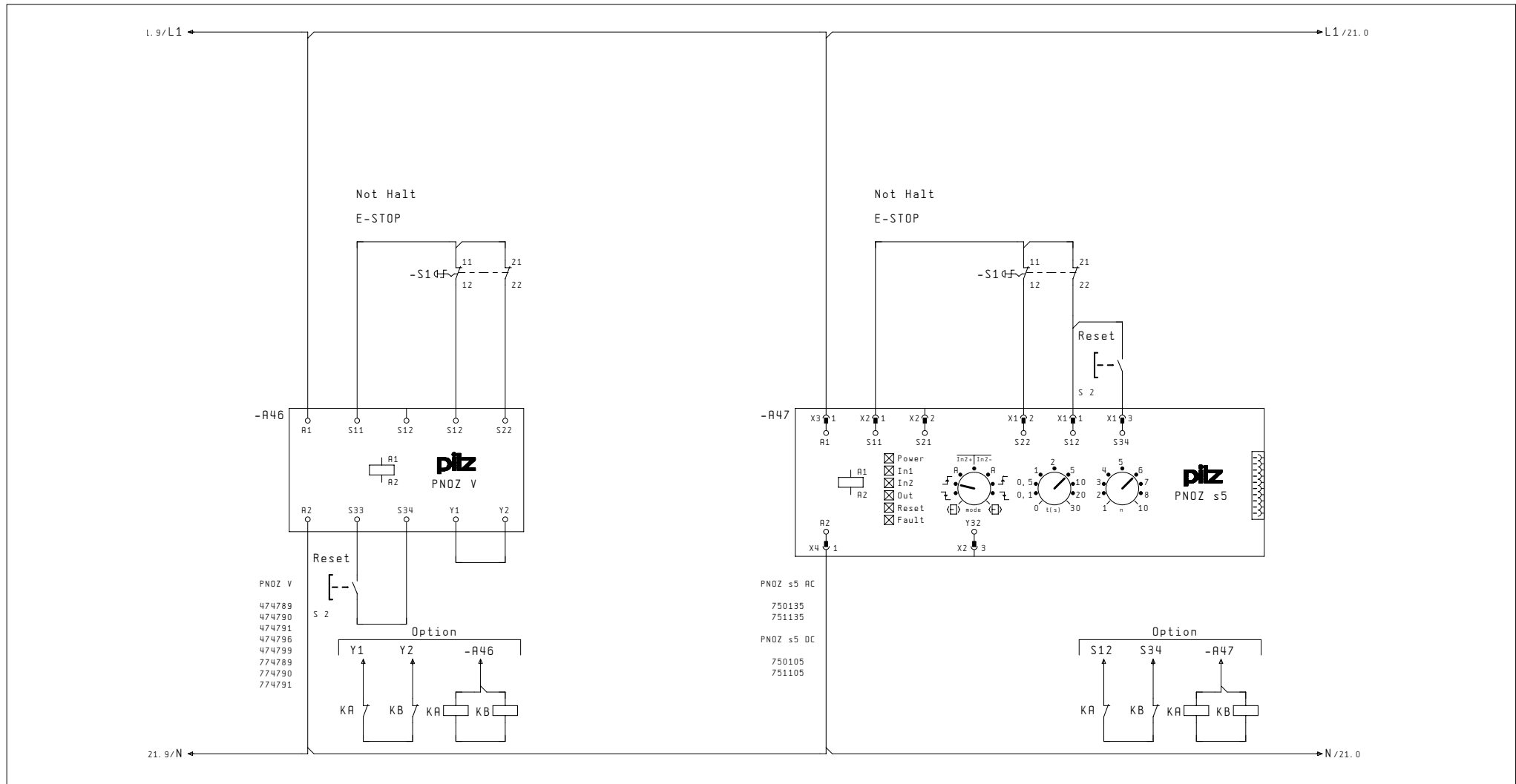

## PST 1 (48 - 230 V AC) – PNOZ s4

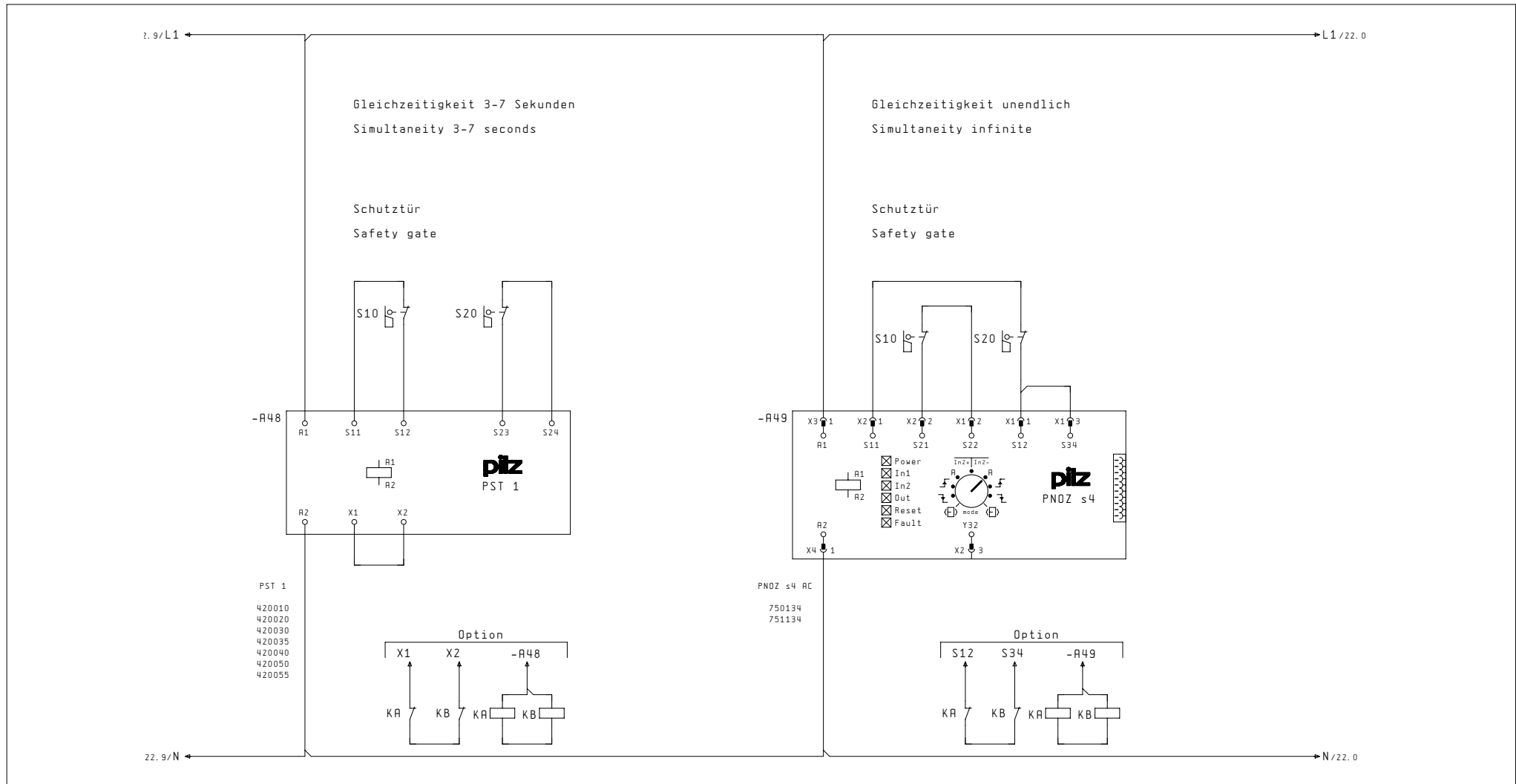

## PST 1 (24 V DC) – PNOZ s3

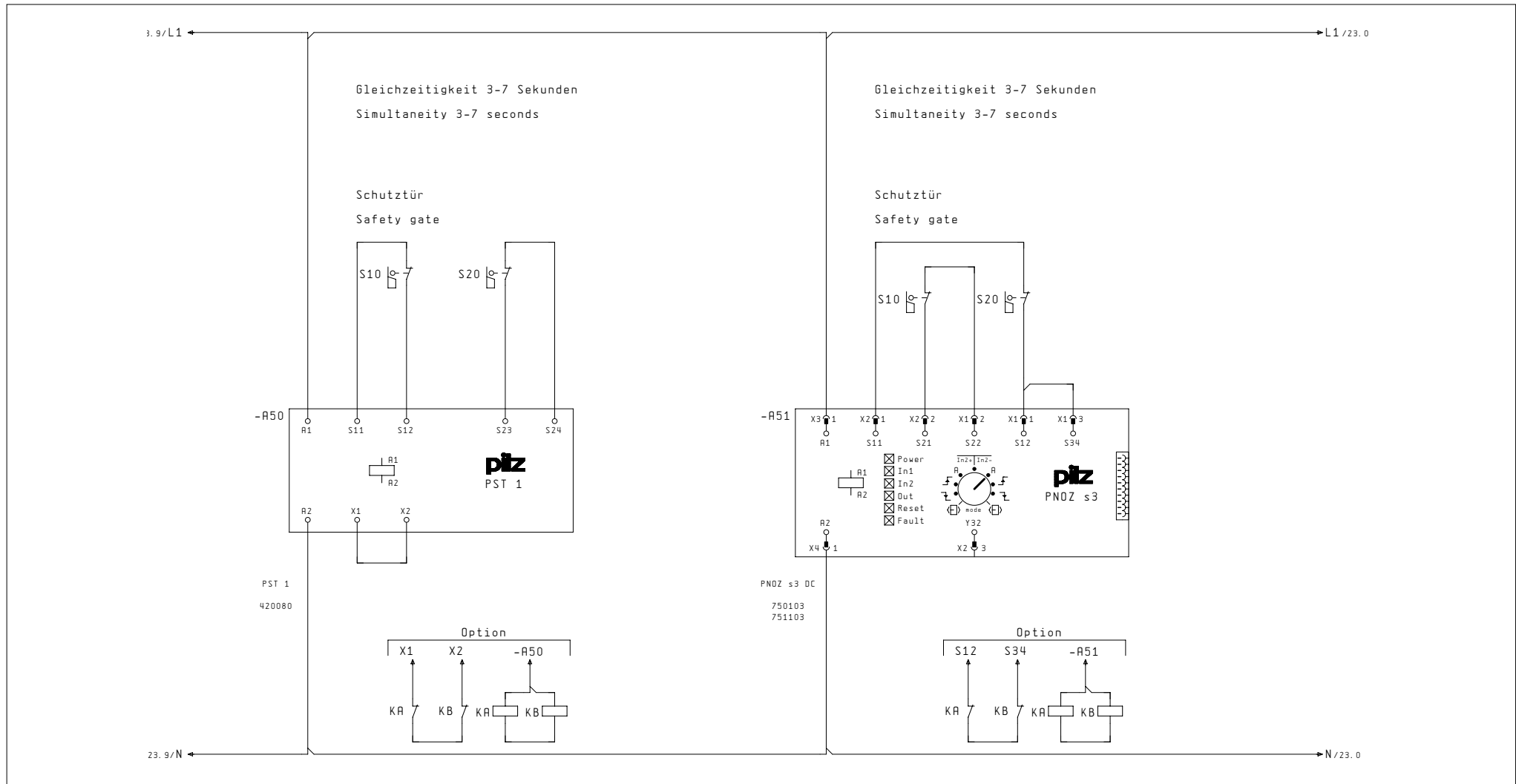

## PST 3 (24 V DC; 48 - 240 V AC) – PNOZ s4

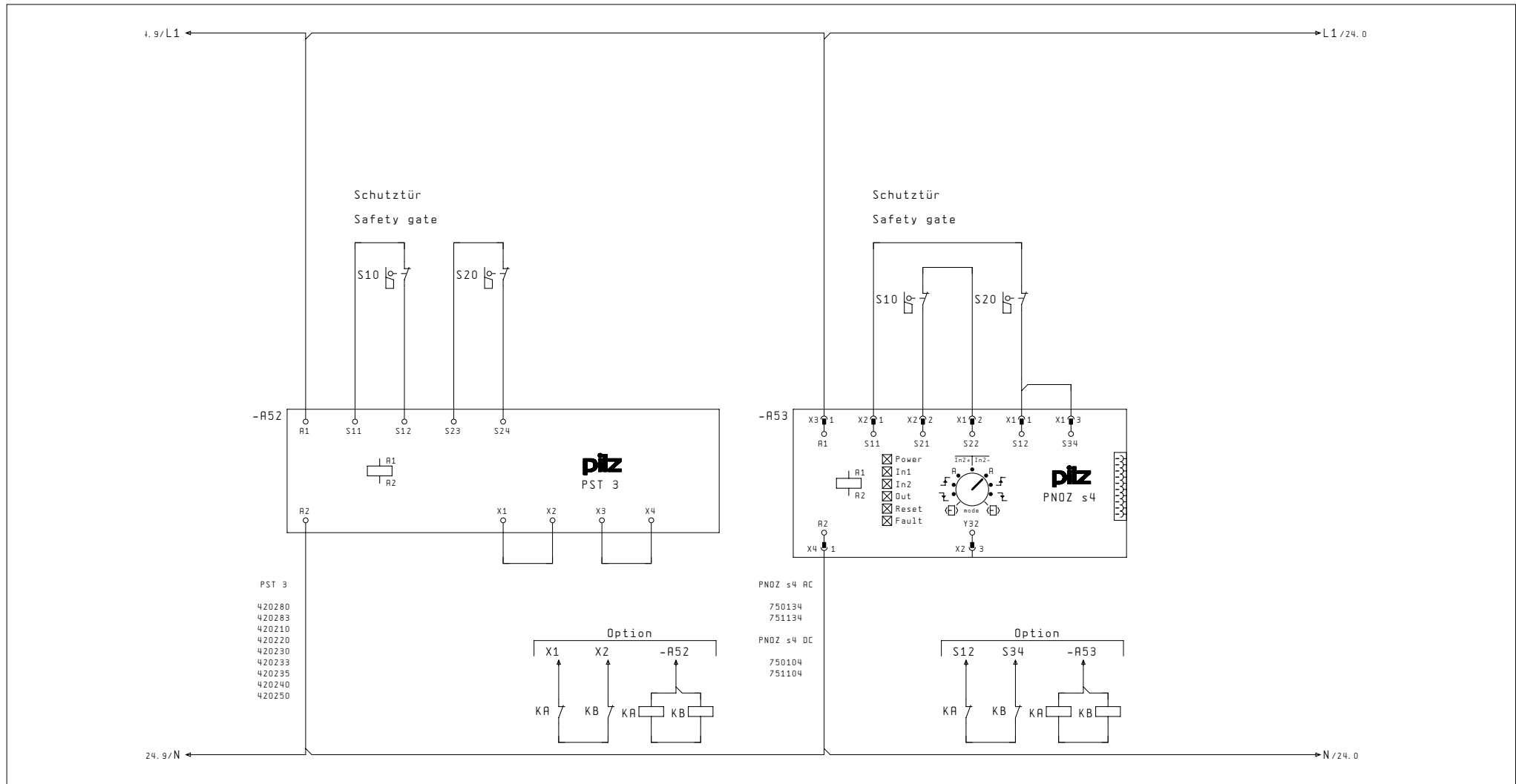

<b>Contents</b>	<b>Page</b>
<b>Service</b>	
Adresses	
	Techniscal offices in Germany
	3.1-2

## Addresses

### Technical offices in Germany



#### ► Filderstadt

Pilz GmbH & Co. KG  
Technisches Büro Filderstadt  
Uhlbergstraße 75/1  
70794 Filderstadt  
Telephone: +49 711 7785244  
Telefax: +49 711 7785245

#### ► Frankfurt

Pilz GmbH & Co. KG  
Technisches Büro Frankfurt  
Heinrich-Böll-Str. 27  
63110 Rodgau  
Telephone: +49 6106 624641  
Telefax: +49 6106 624677

#### ► Gießen

Pilz GmbH & Co. KG  
Technisches Büro Gießen  
Lilienweg 13  
35452 Heuchelheim  
Telephone: +49 641 9661788  
Telefax: +49 641 9661789

#### ► Bielefeld

Pilz GmbH & Co. KG  
Technisches Büro Bielefeld  
Berliner Straße 10  
33813 Oerlinghausen  
Telephone: +49 5202 926012  
Telefax: +49 5202 926013

#### ► Dresden

Pilz GmbH & Co. KG  
Technisches Büro Dresden  
Zinzendorfstraße 13  
01445 Radebeul  
Telephone: +49 351 795155-0  
Telefax: +49 351 795155-40

#### ► Hannover

Pilz GmbH & Co. KG  
Technisches Büro Hannover  
Oldenburger Allee 18  
30659 Hannover  
Telephone: +49 511 616591-0  
Telefax: +49 511 616591-10

#### ► Kaufbeuren

Pilz GmbH & Co. KG  
Technisches Büro Kaufbeuren  
Bergstraße 2 A  
87600 Kaufbeuren  
Telephone: +49 8341 96576-39  
Telefax: +49 8341 96576-60

#### ► Mönchengladbach

Pilz GmbH & Co. KG  
Technisches Büro Mönchengladbach  
Girmen 32  
52525 Heinsberg  
Telephone: +49 2452 939-877  
Telefax: +49 2452 939-878

#### ► München

Pilz GmbH & Co. KG  
Technisches Büro München  
Industriestraße 44 b  
82194 Gröbenzell  
Telephone: +49 8142 4670-0  
Telefax: +49 8142 54541

#### ► Münster

Pilz GmbH & Co. KG  
Technisches Büro Münster  
Franz-Meis-Straße 10  
48163 Münster  
Telephone: +49 251 1626948  
Telefax: +49 251 1626949

#### ► Nürnberg

Pilz GmbH & Co. KG  
Technisches Büro Nürnberg  
Poppenleite 6  
96152 Burghaslach  
Telephone: +49 9552 980568  
Telefax: +49 9552 980569

#### ► Pirmasens

Pilz GmbH & Co. KG  
Technisches Büro Pirmasens  
Karlstraße 22  
66969 Lemberg  
Telephone: +49 6331 6981-11  
Telefax: +49 6331 6981-61

#### ► Siegburg

Pilz GmbH & Co. KG  
Technisches Büro Siegburg  
Adolf-Kolping-Platz 12  
53721 Siegburg  
Telephone: +49 2241 57160  
Telefax: +49 2241 57076

#### ► Singen

Pilz GmbH & Co. KG  
Technisches Büro Singen  
Ob den Häusern 3  
78250 Tengen  
Telephone: +49 7736 921952  
Telefax: +49 7736 921953

#### ► Stuttgart

Pilz GmbH & Co. KG  
Technisches Büro Stuttgart  
Max-Eyth-Straße 7  
73079 Süssen  
Telephone: +49 7162 9413967  
Telefax: +49 7162 9413968

#### ► Traunstein

Pilz GmbH & Co. KG  
Technisches Büro Traunstein  
Edelweißstraße 2  
83346 Bergen  
Telephone: +49 8662 6650-34  
Telefax: +49 8662 6650-35



**▶ AT**

Pilz Ges.m.b.H.  
Sichere Automation  
Modecenterstraße 14  
1030 Wien  
Austria  
Telephone: +43 1 7986263-0  
Telefax: +43 1 7986264  
E-Mail: pilz@pilz.at  
Internet: www.pilz.at

**▶ AU**

Pilz Australia  
Safe Automation  
Suite C1, 756 Blackburn Road  
Clayton, Melbourne VIC 3168  
Australia  
Telephone: +61 3 95446300  
Telefax: +61 3 95446311  
E-Mail: safety@pilz.com.au  
Internet: www.pilz.com.au

**▶ BE ▶ LU**

Pilz Belgium  
Safe Automation  
Bijenstraat 4  
9051 Gent (Sint-Denijs-Westrem)  
Belgium  
Telephone: +32 9 3217570  
Telefax: +32 9 3217571  
E-Mail: info@pilz.be  
Internet: www.pilz.be

**▶ BR**

Pilz do Brasil  
Automação Segura  
Rua Ártico, 123 - Jd. do Mar  
09726-300  
São Bernardo do Campo - SP  
Brazil  
Telephone: +55 11 4337-1241  
Telefax: +55 11 4337-1242  
E-Mail: pilz@pilz.com.br  
Internet: www.pilz.com.br

**▶ CH**

Pilz Industrieelektronik GmbH  
Gewerbepark Hintermättli  
Postfach 6  
5506 Mägenwil  
Switzerland  
Telephone: +41 62 88979-30  
Telefax: +41 62 88979-40  
E-Mail: pilz@pilz.ch  
Internet: www.pilz.ch

**▶ CN**

Pilz Industrial Automation  
Trading (Shanghai) Co., Ltd.  
Safe Automation  
Rm. 704-706  
No. 457 Wu Lu Mu Qi (N) Road  
Shanghai 200040  
China  
Telephone: +86 21 62494658  
Telefax: +86 21 62491300  
E-Mail: sales@pilz.com.cn  
Internet: www.pilz.com.cn

**▶ DE**

Pilz GmbH & Co. KG  
Felix-Wankel-Straße 2  
73760 Ostfildern  
Germany  
Telephone: +49 711 3409-0  
Telefax: +49 711 3409-133  
E-Mail: pilz.gmbh@pilz.de  
Internet: www.pilz.de

**▶ DK**

Pilz Skandinavien K/S  
Safe Automation  
Ellegaardvej 25 L  
6400 Sønderborg  
Denmark  
Telephone: +45 74436332  
Telefax: +45 74436342  
E-Mail: pilz@pilz.dk  
Internet: www.pilz.dk

**▶ ES**

Pilz Industrieelektronik S.L.  
Safe Automation  
Camí Ral, 130  
Polígono Industrial Palou Nord  
08401 Granollers  
Spain  
Telephone: +34 938497433  
Telefax: +34 938497544  
E-Mail: pilz@pilz.es  
Internet: www.pilz.es

**▶ FI**

Pilz Skandinavien K/S  
Safe Automation  
Nuijamiestentie 7  
00400 Helsinki  
Finland  
Telephone: +358 9 27093700  
Telefax: +358 9 27093709  
E-Mail: pilz.fi@pilz.fi  
Internet: www.pilz.fi

**▶ FR**

Pilz France Electronic  
1, rue Jacob Mayer  
BP 12  
67037 Strasbourg Cedex 2  
France  
Telephone: +33 3 88104000  
Telefax: +33 3 88108000  
E-Mail: siege@pilz-france.fr  
Internet: www.pilz.fr

**▶ GB**

Pilz Automation Technology  
Safe Automation  
Willow House, Medicott Close  
Oakley Hay Business Park  
Corby  
Northants NN18 9NF  
United Kingdom  
Telephone: +44 1536 460766  
Telefax: +44 1536 460866  
E-Mail: sales@pilz.co.uk  
Internet: www.pilz.co.uk

**▶ IE**

Pilz Ireland Industrial Automation  
Cork Business and Technology Park  
Model Farm Road  
Cork  
Ireland  
Telephone: +353 21 4346535  
Telefax: +353 21 4804994  
E-Mail: sales@pilz.ie  
Internet: www.pilz.ie

**▶ IT**

Pilz Italia Srl  
Automazione sicura  
Via Meda 2/A  
22060 Novedrate (CO)  
Italy  
Telephone: +39 031 789511  
Telefax: +39 031 789555  
E-Mail: info@pilz.it  
Internet: www.pilz.it

**▶ JP**

Pilz Japan Co., Ltd.  
Safe Automation  
Shin-Yokohama Fujika Building 5F  
2-5-9 Shin-Yokohama  
Kohoku-ku  
Yokohama 222-0033  
Japan  
Telephone: +81 45 471-2281  
Telefax: +81 45 471-2283  
E-Mail: pilz@pilz.co.jp  
Internet: www.pilz.jp

**▶ KR**

Pilz Korea Ltd.  
Safe Automation  
9F Jo-Yang Bld. 50-10  
Chungmuro2-Ga Jung-Gu  
100-861 Seoul  
Republic of Korea  
Telephone: +82 2 2263 9541  
Telefax: +82 2 2263 9542  
E-Mail: info@pilzkorea.co.kr  
Internet: www.pilzkorea.co.kr

**▶ ...**

In many countries we are represented by sales partners.

Please refer to our homepage for further details or contact our headquarters.

**▶ MX**

Pilz de México, S. de R.L. de C.V.  
Automatización Segura  
Circuito Pintores 170  
Cd. Satélite  
Naucalpan, Méx. 53100  
Mexico  
Telephone: +52 55 5572 1300  
Telefax: +52 55 5572 1300  
E-Mail: info@mx.pilz.com  
Internet: www.pilz.com.mx

**▶ NL**

Pilz Nederland  
Veilige automatisering  
Postbus 186  
4130 ED Vianen  
Netherlands  
Telephone: +31 347 320477  
Telefax: +31 347 320485  
E-Mail: info@pilz.nl  
Internet: www.pilz.nl

**▶ NZ**

Pilz New Zealand  
Safe Automation  
5 Nixon Road  
Mangere  
Auckland  
New Zealand  
Telephone: +64 9 6345350  
Telefax: +64 9 6345352  
E-Mail: t.catterson@pilz.co.nz  
Internet: www.pilz.co.nz

**▶ PL**

Pilz Polska Sp. z o.o.  
Safe Automation  
ul. Marywilska 34H  
03-231 Warszawa  
Poland  
Telephone: +48 22 8847100  
Telefax: +48 22 8847109  
E-Mail: info@pilz.pl  
Internet: www.pilz.pl

**▶ Technical support**

+49 711 3409-444

Pilz GmbH & Co. KG  
Felix-Wankel-Straße 2  
73760 Ostfildern, Germany  
Telephone: +49 711 3409-0  
Telefax: +49 711 3409-133  
E-Mail: pilz.gmbh@pilz.de  
Internet: www.pilz.com

**▶ PT**

Pilz Industrieelektronik S.L.  
R. Eng Duarte Pacheco, 120  
4 Andar Sala 21  
4470-174 Maia  
Portugal  
Telephone: +351 229407594  
Telefax: +351 229407595  
E-Mail: pilz@pilz.es  
Internet: www.pilz.es

**▶ SE**

Pilz Skandinavien K/S  
Safe Automation  
Enerigigatan 10 B  
43437 Kungälv  
Sweden  
Telephone: +46 300 13990  
Telefax: +46 300 30740  
E-Mail: pilz.se@pilz.dk  
Internet: www.pilz.se

**▶ TR**

Pilz Emniyet Otomasyon  
Ürünleri ve Hizmetleri Tic. Ltd. Şti.  
Kayışdağı Cd. Beykonağı Plaza  
No:130 K:2 D:2  
Ataşehir/İstanbul  
Turkey  
Telephone: +90 216 5775550  
Telefax: +90 216 5775549  
E-Mail: info@pilz.com.tr  
Internet: www.pilz.com.tr

**▶ US ▶ CA**

Pilz Automation Safety L.P.  
7150 Commerce Boulevard  
Canton  
Michigan 48187  
USA  
Telephone: +1 734 354 0272  
Telefax: +1 734 354 3355  
E-Mail: info@pilzusa.com  
Internet: www.pilz.us



# pilz