

Online-Datenblatt

Drehgeber WDGI 58A

www.wachendorff-automation.de/wdgi58a

Wachendorff Automation

... Systeme und Drehgeber

- Komplette Systeme
- Industrierobuste Drehgeber für Ihren Anwendungsfall
- Standardprogramm und Kundenversionen
- Höchste zulässige Lasten
- 48 Stunden Eilproduktion
- Fertigung in Deutschland
- Weltweites Distributoren-Netzwerk

Drehgeber WDGI 58A



- Standard - Industriedrehgeber
- Aluminium-Druckgussgehäuse mit besonders umweltfreundlicher Pulverbeschichtung
- Durch hochwertige Elektronik bis 25000 Impulse
- Schutzart IP67, am Welleneingang IP65
- Hohe Störungssicherheit
- Voller Anschlusschutz bei 10 VDC bis 30 VDC
- Hohe Ausgabefrequenz bis zu 600 kHz/2 MHz
- Optional: -40 °C bis +85 °C, Druckausgleichsmembran

www.wachendorff-automation.de/wdgi58a

Auflösung	
Max. Impulszahl	bis 25000 I/U
Mechanische Daten	
Gehäuse	
Flanschtyp	Synchroflansch
Flanschmaterial	Aluminium
Flanschmaterial Rückseite	Aluminium-Druckguss, pulverbeschichtet
Gehäusedurchmesser	Ø 58 mm
Spannexzenter	Teilkreis 69 mm
Welle(n)	
Wellenmaterial	Edelstahl
Anlaufdrehmoment	ca. 0,5 Ncm bei Raumtemperatur
Wellendurchmesser	Ø 6 mm
Wellenlänge	L: 12 mm
Max. Wellenbelastung radial	125 N
Max. Wellenbelastung axial	70 N
Lager	
Lagertyp	2 Präzisionskugellager
Lebensdauer	3 x 10 ⁸ U bei 100 % Lagerlast 5 x 10 ⁹ U bei 40 % Lagerlast 4 x 10 ¹⁰ U bei 20 % Lagerlast
Max. Betriebsdrehzahl	10000 min ⁻¹
Kenndaten für funktionale Sicherheit	
MTTF _d	200 a
Gebrauchsdauer (TM)	25 a
Lebensdauer Lager (L10h)	4 x 10 ¹⁰ U bei 20 % Lagerlast und 10000 min ⁻¹
Diagnosedeckungsgrad (DC)	0 %
Elektrische Daten	
Betriebsspannung/ Eigenstromaufnahme	4,75 VDC bis 5,5 VDC: typ. 100 mA
Betriebsspannung/ Eigenstromaufnahme	5 VDC bis 30 VDC: typ. 70 mA
Betriebsspannung/ Eigenstromaufnahme	10 VDC bis 30 VDC: typ. 100 mA
Ausgangsschaltung	TTL TTL, RS422 kompatibel, inv. HTL HTL, inv. 1 Vss Sin/Cos

Impulsfrequenz	TTL bis 5000 I/U: max. 200 kHz HTL bis 5000 I/U: max. 200 kHz TTL über 1200 I/U: max. 2 MHz HTL über 1200 I/U: max. 600 kHz 1 Vss Sin/Cos: max. 100 kHz
Kanäle	AB ABN und invertierte Signale
Belastung	max. 40 mA / Kanal bei 1 Vss Sin/Cos: min. 120 Ohm
Anschlusschutz	nur bei F24, G24, H24, I24, P24, R24
Genauigkeit	
Phasenversatz	90° ± max. 7,5 % einer Teilungslänge
Impuls-/Pausenverhältnis	5000 I/U: 50 % ± max. 7 % >5000 I/U: 50 % ± max. 10 %

Allgemeine Daten	
Gewicht	ca. 230 g
Anschluss	Kabel- oder Steckerabgang
Schutzart (EN 60529)	IP67, am Welleneingang IP65
Arbeitstemperatur	Steckerabgang: -20 °C bis +85 °C, Kabelabgang: -20 °C bis +80 °C (Option ACA: -40 °C bis +85 °C) 1 Vss: -10 °C bis +70 °C
Lagerungstemperatur	Steckerabgang: -30 °C bis +85 °C, Kabelabgang: -30 °C bis +80 °C, Option ACA: -40 °C bis +85 °C

Weitere Informationen	
Allgemein technische Daten und Sicherheitshinweise http://www.wachendorff-automation.de/atd	
Passendes Zubehör http://www.wachendorff-automation.de/zub	

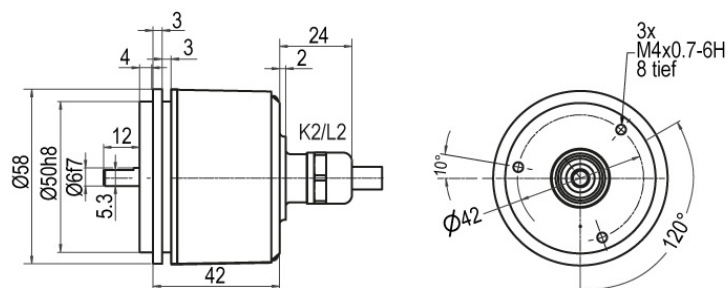
WDGI 58A: Kabelanschluss K2, L2, axial, mit 2 m Kabel

Beschreibung
ABN inv. möglich
L2 axial, Schirm mit Gebergehäuse leitend verbunden

•

K2 axial, Schirm offen

•

Anschlussbelegungen

	K2, L2	K2, L2	K2, L2	K2, L2	L2
Schaltung	G05, G24	F05, H05, F24, H24, H30	I05, I24, 524	P05, R05, P24, R24, 245, 645, R30	SIN
GND	WH	WH	WH	WH	WH
+UB	BN	BN	BN	BN	BN
A	GN	GN	GN	GN	GN
B	YE	YE	YE	YE	GY
N	GY	GY	GY	GY	-
Frühwarnausgang	PK	-	PK	-	-
A inv.	-	-	RD	RD	YE
B inv.	-	-	BK, (BU bei ACA)	BK, (BU bei ACA)	PK
N inv.	-	-	VT	VT	-
Schirm	Litze	Litze	Litze	Litze	Litze

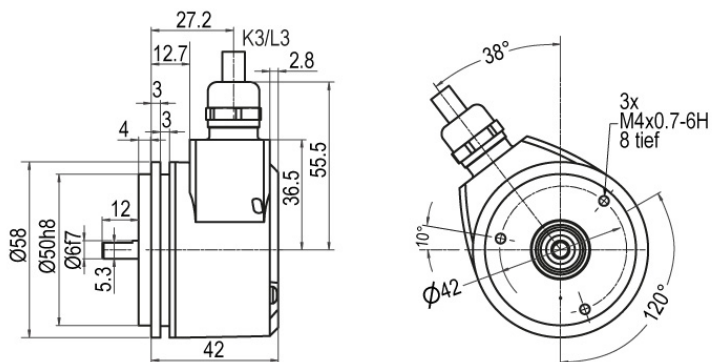
WDGI 58A: Kabelanschluss K3, L3, radial, mit 2 m Kabel

Beschreibung
ABN inv. möglich
K3 radial, Schirm offen

•

L3 radial, Schirm mit Gebergehäuse leitend verbunden

•





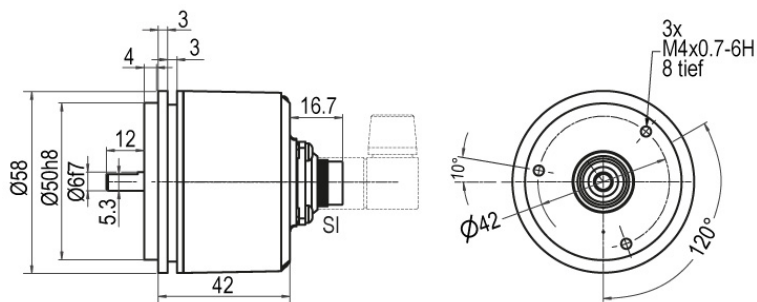





Anschlussbelegungen

	K3, L3	K3, L3	K3, L3	K3, L3	L3
Schaltung	G05, G24	F05, H05, F24, H24, H30	I05, I24, 524	P05, R05, P24, R24, 245, 645, R30	SIN
GND	WH	WH	WH	WH	WH
+UB	BN	BN	BN	BN	BN
A	GN	GN	GN	GN	GN
B	YE	YE	YE	YE	GY
N	GY	GY	GY	GY	-
Frühwarnausgang	PK	-	PK	-	-
A inv.	-	-	RD	RD	YE
B inv.	-	-	BK, (BU bei ACA)	BK, (BU bei ACA)	PK
N inv.	-	-	VT	VT	-
Schirm	Litze	Litze	Litze	Litze	Litze

WDGI 58A: Stecker (M16x0,75) SI, axial, 5-, 6-, 8-, 12-polig

Beschreibung
ABN inv. möglich

SI5	axial, 5-polig, Stecker mit Gebergehäuse leitend verbunden	-
SI6	axial, 6-polig, Stecker mit Gebergehäuse leitend verbunden	-
SI8	axial, 8-polig, Stecker mit Gebergehäuse leitend verbunden	•
SI12	axial, 12-polig, Stecker mit Gebergehäuse leitend verbunden	•



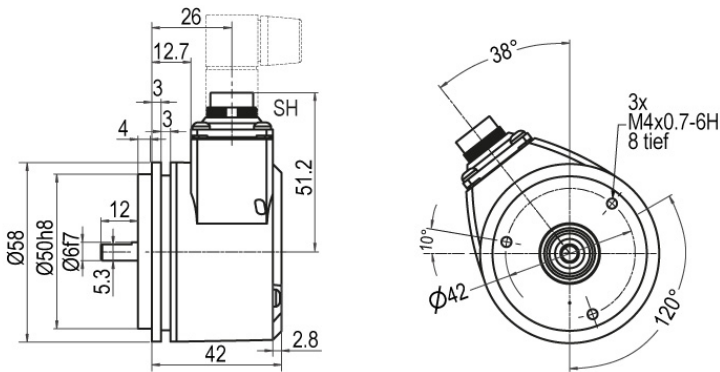







Anschlussbelegungen

	SI5	SI6	SI6	SI8	SI8	SI8	SI12	SI12	SI12	SI12	SI12
	5-polig	6-polig	6-polig	8-polig	8-polig	8-polig	12-polig	12-polig	12-polig	12-polig	12-polig
Schaltung	 F05, H05, F24, H24, H30	 G05, G24	 F05, H05, F24, H24, H30	 F05, H05, F24, H24, H30	 P05, R05, P24, R24, R30, 245, 645	 SIN	 G05, G24	 F05, H05, F24, H24, H30	 I05, I24, 524	 P05, R05, P24, R24, 245, 645, R30	 SIN
GND	1	6	6	1	1	1	K, L	K, L	K, L	K, L	K, L
+UB	2	1	1	2	2	2	M, B	M, B	M, B	M, B	M, B
A	3	2	2	3	3	3	E	E	E	E	E
B	4	4	4	4	4	4	H	H	H	H	H
N	5	3	3	5	5	-	C	C	C	C	-
Frühwarnausgang	-	5	-	-	-	-	G	-	G	-	-
A inv.	-	-	-	-	6	6	-	-	F	F	F
B inv.	-	-	-	-	7	7	-	-	A	A	A
N inv.	-	-	-	-	8	-	-	-	D	D	-
n. c.	-	-	5	6, 7, 8	-	5, 8	A, D, F, J	A, D, F, G, J	J	G, J	D, G, J
Schirm	-	-	-	-	-	-	-	-	-	-	-

WDGI 58A: Stecker (M16x0,75) SH, radial, 5-, 6-, 8-, 12-polig

Beschreibung
ABN inv. möglich

SH5	radial, 5-polig, Stecker mit Gebergehäuse leitend verbunden	-
SH6	radial, 6-polig, Stecker mit Gebergehäuse leitend verbunden	-
SH8	radial, 8-polig, Stecker mit Gebergehäuse leitend verbunden	•
SH12	radial, 12-polig, Stecker mit Gebergehäuse leitend verbunden	•

Anschlussbelegungen

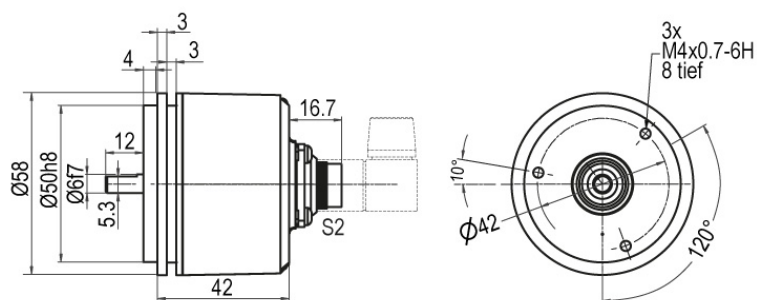
	SH5	SH6	SH6	SH8	SH8	SH8	SH12	SH12	SH12	SH12	SH12
	5-polig	6-polig	6-polig	8-polig	8-polig	8-polig	12-polig	12-polig	12-polig	12-polig	12-polig
											
Schaltung	F05, H05, F24, H24, H30	G05, G24	F05, H05, F24, H24, H30	F05, H05, F24, H24, H30	P05, R05, P24, R24, R30, 245, 645	SIN	G05, G24	F05, H05, F24, H24, H30	I05, I24, 524	P05, R05, P24, R24, 245, 645, R30	SIN
GND	1	6	6	1	1	1	K, L	K, L	K, L	K, L	K, L
+UB	2	1	1	2	2	2	M, B	M, B	M, B	M, B	M, B
A	3	2	2	3	3	3	E	E	E	E	E
B	4	4	4	4	4	4	H	H	H	H	H
N	5	3	3	5	5	-	C	C	C	C	-
Frühwarnausgang	-	5	-	-	-	-	G	-	G	-	-
A inv.	-	-	-	-	6	6	-	-	F	F	F
B inv.	-	-	-	-	7	7	-	-	A	A	A
N inv.	-	-	-	-	8	-	-	-	D	D	-
n. c.	-	-	5	6, 7, 8	-	5, 8	A, D, F, J	A, D, F, G, J	J	G, J	D, G, J
Schirm	-	-	-	-	-	-	-	-	-	-	-

WDGI 58A: Stecker (M16x0,75) S2, axial, 7-polig

Beschreibung
ABN inv. möglich
S2 axial, 7-polig, Stecker mit Gebergehäuse leitend verbunden

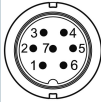

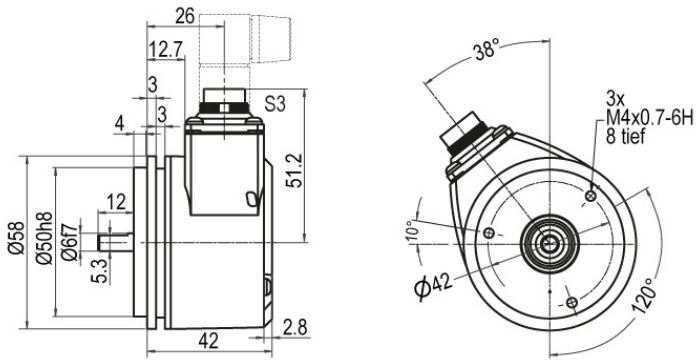
-

Anschlussbelegungen		
	S2 7-polig	S2 7-polig
		
Schaltung	G05, G24	F05, H05, F24, H24, H30
GND	1	1
+UB	2	2
A	3	3
B	4	4
N	5	5
Frühwarnausgang	6	-
A inv.	-	-
B inv.	-	-
N inv.	-	-
n. c.	7	6, 7
Schirm	-	-

WDGI 58A: Stecker (M16x0,75) S3, radial, 7-polig

Beschreibung
ABN inv. möglich
S3 radial, 7-polig, Stecker mit Gebergehäuse leitend verbunden

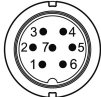

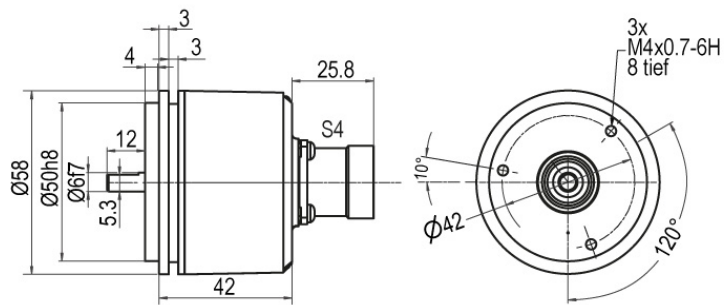

-

Anschlussbelegungen

	S3 7-polig	S3 7-polig
		
Schaltung	G05, G24	F05, H05, F24, H24, H30
GND	1	1
+UB	2	2
A	3	3
B	4	4
N	5	5
Frühwarnausgang	6	-
A inv.	-	-
B inv.	-	-
N inv.	-	-
n. c.	7	6, 7
Schirm	-	-

WDGI 58A: Stecker (M23) S4, axial, 12-polig

Beschreibung
ABN inv. möglich
S4 axial, 12-polig, Stecker mit Gebergehäuse leitend verbunden

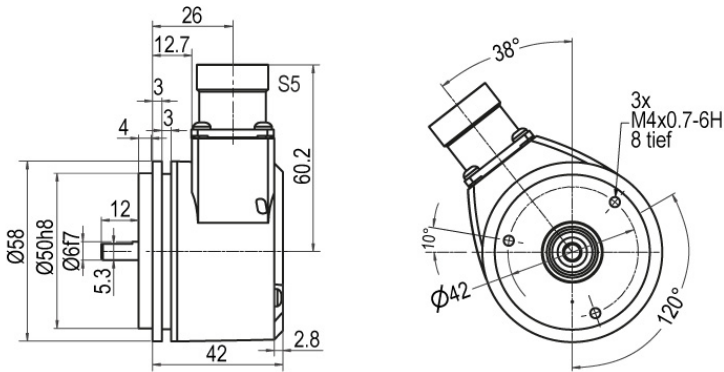

•

Anschlussbelegungen					
	S4	S4	S4	S4	S4
	12-polig	12-polig	12-polig	12-polig	12-polig
					
Schaltung	G05, G24	F05, H05, F24, H24, H30	I05, I24, 524	P05, R05, P24, R24, 245, 645, R30	SIN
GND	10	10	10	10	10
+UB	12	12	12	12	12
A	5	5	5	5	5
B	8	8	8	8	8
N	3	3	3	3	-
Frühwarnausgang	11	-	11	-	-
A inv.	-	-	6	6	6
B inv.	-	-	1	1	1
N inv.	-	-	4	4	-
n. c.	1, 2, 4, 6, 7, 9	1, 2, 4, 6, 7, 9, 11	2, 7, 9	2, 7, 9, 11	2, 3, 4, 7, 9, 11
Schirm	-	-	-	-	-

WDGI 58A: Stecker (M23) S5, radial, 12-polig

Beschreibung
ABN inv. möglich
S5 radial, 12-polig, Stecker mit Gebergehäuse leitend verbunden

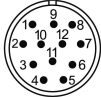
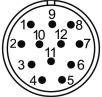
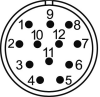
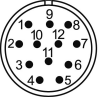
•

Anschlussbelegungen

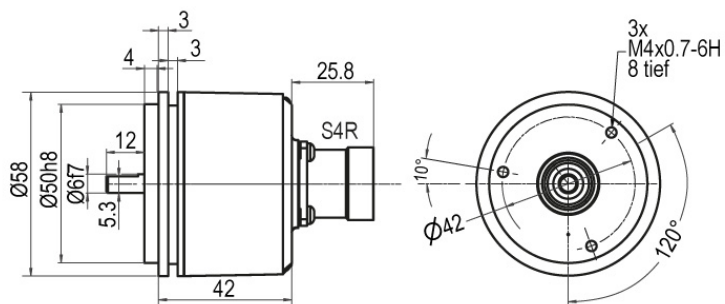
	S5	S5	S5	S5	S5
	12-polig	12-polig	12-polig	12-polig	12-polig
					
Schaltung	G05, G24	F05, H05, F24, H24, H30	I05, I24, 524	P05, R05, P24, R24, 245, 645, R30	SIN
GND	10	10	10	10	10
+UB	12	12	12	12	12
A	5	5	5	5	5
B	8	8	8	8	8
N	3	3	3	3	-
Frühwarnausgang	11	-	11	-	-
A inv.	-	-	6	6	6
B inv.	-	-	1	1	1
N inv.	-	-	4	4	-
n. c.	1, 2, 4, 6, 7, 9	1, 2, 4, 6, 7, 9, 11	2, 7, 9	2, 7, 9, 11	2, 3, 4, 7, 9, 11
Schirm	-	-	-	-	-

WDGI 58A: Stecker (M23) S4R, axial, 12-polig (rechtsdrehend)

Beschreibung
ABN inv. möglich
S4R axial, 12-polig, Stecker mit Gebergehäuse leitend verbunden

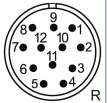
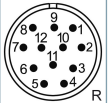
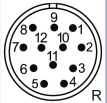
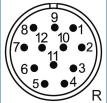
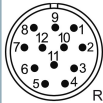

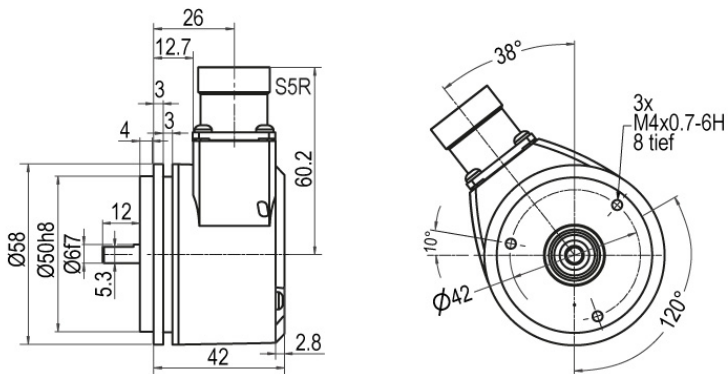
•

Anschlussbelegungen					
	S4R	S4R	S4R	S4R	S4R
	12-polig	12-polig	12-polig	12-polig	12-polig
					
Schaltung	G05, G24	F05, H05, F24, H24, H30	I05, I24, 524	P05, R05, P24, R24, 245, 645, R30	SIN
GND	10	10	10	10	10
+UB	12	12	12	12	12
A	5	5	5	5	5
B	8	8	8	8	8
N	3	3	3	3	-
Frühwarnausgang	11	-	11	-	-
A inv.	-	-	6	6	6
B inv.	-	-	1	1	1
N inv.	-	-	4	4	-
n. c.	1, 2, 4, 6, 7, 9	1, 2, 4, 6, 7, 9, 11	2, 7, 9	2, 7, 9, 11	2, 3, 4, 7, 9, 11
Schirm	-	-	-	-	-

WDGI 58A: Stecker (M23) S5R, radial, 12-polig (rechtsdrehend)

Beschreibung
ABN inv. möglich
S5R radial, 12-polig, Stecker mit Gebergehäuse leitend verbunden

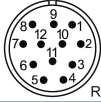
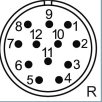
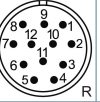
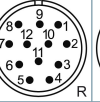
•



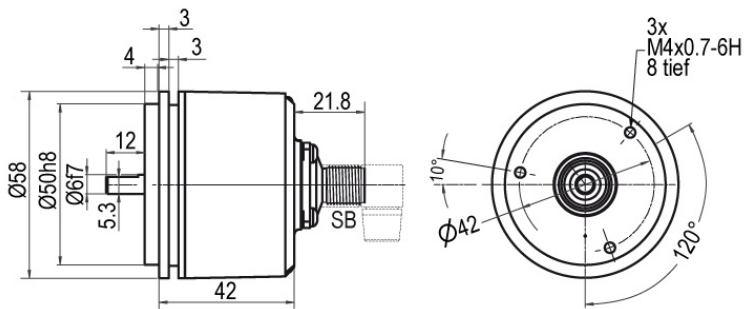





Anschlussbelegungen

	S5R	S5R	S5R	S5R	S5R
	12-polig	12-polig	12-polig	12-polig	12-polig
					
Schaltung	G05, G24	F05, H05, F24, H24, H30	I05, I24, 524	P05, R05, P24, R24, 245, 645, R30	SIN
GND	10	10	10	10	10
+UB	12	12	12	12	12
A	5	5	5	5	5
B	8	8	8	8	8
N	3	3	3	3	-
Frühwarnausgang	11	-	11	-	-
A inv.	-	-	6	6	6
B inv.	-	-	1	1	1
N inv.	-	-	4	4	-
n. c.	1, 2, 4, 6, 7, 9	1, 2, 4, 6, 7, 9, 11	2, 7, 9	2, 7, 9, 11	2, 3, 4, 7, 9, 11
Schirm	-	-	-	-	-

WDGI 58A: Sensor-Stecker (M12x1) SB, axial, 4-, 5-, 8-, 12-polig

Beschreibung
ABN inv. möglich





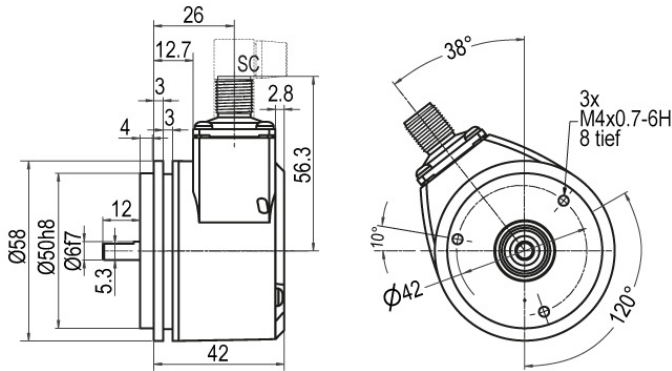



SB4	axial, 4-polig, Stecker mit Gebergehäuse leitend verbunden	-
SB5	axial, 5-polig, Stecker mit Gebergehäuse leitend verbunden	-
SB8	axial, 8-polig, Stecker mit Gebergehäuse leitend verbunden	•
SB12	axial, 12-polig, Stecker mit Gebergehäuse leitend verbunden	•

Anschlussbelegungen

	SB4	SB5	SB8	SB8	SB8	SB12	SB12	SB12	SB12
	4-polig	5-polig	8-polig	8-polig	8-polig	12-polig	12-polig	12-polig	12-polig
									
Schaltung	F05, H05, F24, H24, H30	F05, H05, F24, H24, H30	F05, H05, F24, H24, H30	P05, R05, P24, R24, R30, 245, 645	SIN	G05, G24	F05, H05, F24, H24, H30	I05, I24, 524	P05, R05, P24, R24, 245, 645, R30
GND	3	3	1	1	1	3	3	3	3
+UB	1	1	2	2	2	1	1	1	1
A	2	4	3	3	3	4	4	4	4
B	4	2	4	4	5	6	6	6	6
N	-	5	5	5	-	8	8	8	8
Frühwarnausgang	-	-	-	-	-	5	-	5	-
A inv.	-	-	-	6	4	-	-	9	9
B inv.	-	-	-	7	6	-	-	7	7
N inv.	-	-	-	8	-	-	-	10	10
n. c.	-	-	6, 7, 8	-	7, 8	2, 7, 9, 10, 11, 12	2, 5, 7, 9, 10, 11, 12	2, 11, 12	2, 5, 11, 12
Schirm	-	-	-	-	-	-	-	-	-

WDGI 58A: Sensor-Stecker (M12x1) SC, radial, 4-, 5-, 8-, 12-polig

Beschreibung	ABN inv. möglich
SC4 radial, 4-polig, Stecker mit Gebergehäuse leitend verbunden	-
SC5 radial, 5-polig, Stecker mit Gebergehäuse leitend verbunden	-
SC8 radial, 8-polig, Stecker mit Gebergehäuse leitend verbunden	•
SC12 radial, 12-polig, Stecker mit Gebergehäuse leitend verbunden	•

Anschlussbelegungen									
	SC4	SC5	SC8	SC8	SC8	SC12	SC12	SC12	SC12
	4-polig	5-polig	8-polig	8-polig	8-polig	12-polig	12-polig	12-polig	12-polig
									
Schaltung	F05, H05, F24, H24, H30	F05, H05, F24, H24, H30	F05, H05, F24, H24, H30	P05, R05, P24, R24, R30, 245, 645	SIN	G05, G24	F05, H05, F24, H24, H30	I05, I24, 524	P05, R05, P24, R24, 245, 645, R30
GND	3	3	1	1	1	3	3	3	3
+UB	1	1	2	2	2	1	1	1	1
A	2	4	3	3	3	4	4	4	4
B	4	2	4	4	5	6	6	6	6
N	-	5	5	5	-	8	8	8	8
Frühwarnausgang	-	-	-	-	-	5	-	5	-
A inv.	-	-	-	6	4	-	-	9	9
B inv.	-	-	-	7	6	-	-	7	7
N inv.	-	-	-	8	-	-	-	10	10
n. c.	-	-	6, 7, 8	-	7, 8	2, 7, 9, 10, 11, 12	2, 5, 7, 9, 10, 11, 12	2, 11, 12	2, 5, 11, 12
Schirm	-	-	-	-	-	-	-	-	-

Optionen

Besonders leichtlaufender Geber

Der Drehgeber WDGI 58A ist auch als besonders leichtlaufender Geber erhältlich. Dabei ändert sich das Anlaufdrehmoment auf 0,25 Ncm und die Schutzart am Welleneingang auf IP50.

Bestell-Code

AAC

Niedrig Temperatur

Der Drehgeber WDGI 58A mit den Ausgangsschaltungen F24, G24, H24, I24, P24, R24, F05, G05, H05, I05, P05, R05, 245, 524, 645 ist auch mit dem erweiterten Temperaturbereich -40 °C bis +85 °C (gemessen am Flansch) lieferbar.

Bestell-Code

ACA

Druckausgleichsmembran

Der Drehgeber WDGI 58A ist optional auch mit einer Druckausgleichsmembran erhältlich. Diese verhindert das Eindringen von Wasser in das Drehgebergehäuse bei hoher Luftfeuchtigkeit. Schutzart bis IP67, Temperaturbereich und Salznebelbeständigkeit bleiben erhalten. Chemikalien- und Lösemittelbeständig nach DIN EN ISO2812-1

Bestell-Code

ACR

Kabellänge

Der Drehgeber WDGI 58A ist auch mit mehr als 2 m Kabel erhältlich. Die max. Kabellänge ist abhängig von der Betriebsspannung und der Frequenz; siehe www.wachendorff-automation.de/atd

Bestell-Code

XXX = Dezimeter

Bei der Bestellung ergänzen Sie bitte die Bestellnummer mit einer 3-stelligen Ziffer welche die Länge in Dezimeter angibt.

Beispiel: 5 m Kabellänge = 050

Beispl. Bestell-Nr.	Typ					Ihr Drehgeber
WDGI 58A	WDGI 58A					WDGI 58A
Wellendurchmesser						
06	06					
Impulszahlen:						
5000	2, 5, 10, 15, 20, 24, 25, 30, 36, 40, 48, 50, 60, 64, 72, 87, 90, 100, 120, 125, 127, 128, 150, 160, 180, 200, 216, 236, 240, 250, 254, 256, 300, 314, 320, 360, 400, 500, 512, 571, 600, 625, 720, 750, 768, 800, 810, 900, 1000, 1024, 1200, 1250, 1270, 1440, 1500, 1800, 2000, 2048, 2400, 2500, 3000, 3600, 4000, 4096, 4685, 5000, 10000, 12500, 20000, 25000 1 Vss Sin/Cos nur bei 1024, 2048 Andere Impulszahlen auf Anfrage					
Impulsfolge:						
ABN	AB, ABN (SIN: AB)					
Ausgangsschaltung						
G24	Auflösung I/U	Betriebsspannung VDC	Ausgangsschaltung	Frühwarnausgang	Bestellschlüssel	
	bis 2500	5 - 30	HTL	-	H30	
		5 - 30	HTL invertiert	-	R30	
	bis 5000	4,75 - 5,5	TTL	•	G05	
		4,75 - 5,5	TTL	-	H05	
		4,75 - 5,5	TTL, RS422 komp., invertiert	•	I05	
		4,75 - 5,5	TTL, RS422 komp., invertiert	-	R05	
		10 - 30	HTL	•	G24	
		10 - 30	HTL	-	H24	
		10 - 30	HTL invertiert	•	I24	
		10 - 30	HTL invertiert	-	R24	
		10 - 30	TTL, RS422 komp., invertiert	•	524	
		10 - 30	TTL, RS422 komp., invertiert	-	245	
	(höhere Frequenz) 1200 bis 25000	4,75 - 5,5	TTL	-	F05	
		4,75 - 5,5	TTL, RS422 komp., invertiert	-	P05	
		10 - 30	HTL	-	F24	
		10 - 30	HTL invertiert	-	P24	
		10 - 30	TTL, RS422 komp., invertiert	-	645	
	1024, 2048	4,75 - 5,5	1 Vss Sin/Cos	-	SIN	

Elektrischer Anschluss				
	Beschreibung	ABN inv. mögl.	Bestellschlüssel	
K2	Kabel: Länge (2 m Standard, WDG 58T: 1 m)			
	axial, Schirm offen	•	K2	
	axial, Schirm mit Gebergehäuse leitend verbunden	•	L2	
	radial, Schirm offen	•	K3	
	radial, Schirm mit Gebergehäuse leitend verbunden	•	L3	
	Stecker: (Stecker mit Gebergehäuse leitend verbunden)			
	Stecker, M16x0,75, 5-polig, axial	-	SI5	
	Stecker, M16x0,75, 5-polig, radial	-	SH5	
	Stecker, M16x0,75, 6-polig, axial	-	SI6	
	Stecker, M16x0,75, 6-polig, radial	-	SH6	
	Stecker, M16x0,75, 8-polig, axial	•	SI8	
	Stecker, M16x0,75, 8-polig, radial	•	SH8	
	Stecker, M16x0,75, 12-polig, axial	•	SI12	
	Stecker, M16x0,75, 12-polig, radial	•	SH12	
	Stecker, M16x0,75, 7-polig, axial	-	S2	
	Stecker, M16x0,75, 7-polig, radial	-	S3	
	Stecker, M23, 12-polig, axial	•	S4	
	Stecker, rechtsdrehend, M23, 12-polig, axial	•	S4R	
	Stecker, M23, 12-polig, radial	•	S5	
	Stecker, rechtsdrehend, M23, 12-polig, radial	•	S5R	
	Sensorstecker, M12x1, 4-polig, axial	-	SB4	
	Sensorstecker, M12x1, 4-polig, radial	-	SC4	
	Sensorstecker, M12x1, 5-polig, axial	-	SB5	
	Sensorstecker, M12x1, 5-polig, radial	-	SC5	
	Sensorstecker, M12x1, 8-polig, axial	•	SB8	
	Sensorstecker, M12x1, 8-polig, radial	•	SC8	
	Sensorstecker, M12x1, 12-polig, axial	•	SB12	
	Sensorstecker, M12x1, 12-polig, radial	•	SC12	
	Optionen			
		Beschreibung	Bestellschlüssel	
		Keine Option gewählt	Leer	
		Besonders leichtlaufender Geber	AAC	
	Niedrig Temperatur	ACA		
	Druckausgleichsmembran	ACR		
	Kabellänge	XXX = Dezimeter		

Bsp-Bestell-Nr.=	WDGI 58A	06	5000	ABN	G24	K2		WDGI 58A						Ihr Drehgeber
-------------------------	----------	----	------	-----	-----	----	--	----------	--	--	--	--	--	----------------------

Ansprechpartner



Für technische Fragen
(Anwendungsberatung, Anpassungsentwicklung, inkrementale Drehgeberauswahl)
wenden Sie sich bitte an:

Technische Anwendungsberatung inkrementale Drehgeber

Thomas Post

Tel: +49 6722 9965131

Fax: +49 6722 996570

E-Mail: support-wdgi@wachendorff.de



Für kaufmännische Fragen und Angebote
wenden Sie sich bitte an:

Vertriebsinnendienst

Tatjana Weigelt

Tel: +49 6722 9965242

Fax: +49 6722 996570

E-Mail: sales-wa@wachendorff.de



Im deutschsprachigen Ausland
wenden Sie sich bitte an:

Ihren Distributor

<http://www.wachendorff-automation.de/distributoren.html>



Wachendorff Automation GmbH & Co. KG
Industriestrasse 7 • D-65366 Geisenheim

Tel: +49 67 22 / 99 65 25

Fax: +49 67 22 / 99 65 70

E-Mail: wdg@wachendorff.de

www.wachendorff-automation.de

