

1. DESCRIZIONE RIDUTTORI

1. DESCRIPTION OF GEAR UNITS

1. GETRIEBE-BESCHREIBUNG

SL

Versione
Version
Ausführung

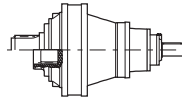

SL

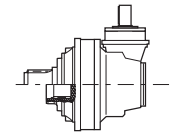

SC

3002

Grandezza
Size
Größe

3001, 3002, 3003, 3004
4001, 4002, 4003, 4004

3002, 3003, 3004
4002, 4003, 4004

1 stadio stage Etappe 2 stadi stages Etappen 3 stadi stages Etappen 4 stadi stages Etappen

2 stadi stages Etappen 3 stadi stages Etappen 4 stadi stages Etappen

MP

Configurazione uscita
Output configuration
Abtriebsanordnung

FE

FAR

FS

MP

MP1

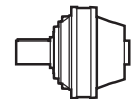
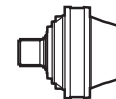
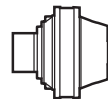
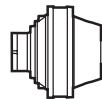

15.96

Rapporto effettivo
Effective ratio
Effektives Übersetzungsverhältnis

↓ Vedere tabelle dati tecnici / See data sheet / Siehe Tabelle der technischen Daten (i_{eff})

i_{eff}	n_1 [rpm]									T_{MAX}	P_T	
	1500			1000			500					
	n_2 [rpm]	T_2 [Nm]	P_2 [kW]	n_2 [rpm]	T_2 [Nm]	P_2 [kW]	n_2 [rpm]	T_2 [Nm]	P_2 [kW]			
SL3002	15.96 17.86	94 84	21760 22471	214 198	63 56	24574 25378	161 149	31.3 28.0	30255 31255	99 92	76000 76000	38 38

S-65CR1

Configurazione entrata
Input configuration
Abtriebsanordnung

Supporti maschio in entrata
Cylindrical male input shaft
Antriebswellenstümpfe Daten

Freni lamellari
Multidisc brakes
Lamellenbremsen

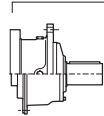

S-45CR1
S-46C1
S-65CR1
S-90CR1
ISL150
ISL250
ISL300
IS300
IS600
IS850

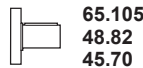

65.105
48.82
45.70

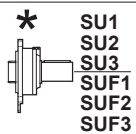

Entrate universali
Universal inputs
Universalantriebe

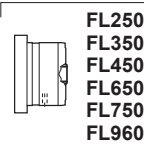

FL250
FL350
FL450
FL650
FL750
FL960

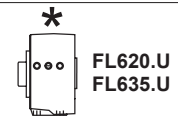

* Solo per entrata universale
Only for universal input
Nur für Universalantriebe

B3

Posizioni di montaggio
Mounting position
Einbaulage

B3 B3A V5B
V5 B3B V6B
V6 B3C
B3D

FR400

Accessori uscita
Output shaft accessories
Abtriebsseitiges Zubehör

Barra scanalata
Splined bar
Zugspindel

BS...



Rondella di fermo
Shaft cover
Gegenscheibe

RDF...



Flangia ruota
Driving flange
Radnabenflansch

FR...



Manicotto scanalato
Splined bush
Keilmuffe

MS...



Esempio di designazione
Model code example
Beispiel der Kennzeichnung

SL3002/MP/15.96/S-65CR1/B3/FR400

S300

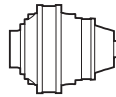

10000
HOURS LIFE

i _{eff}	n ₁ [rpm]									T ₂ MAX [Nm]	P _T [kW]
	1500			1000			500				
	n ₂ [rpm]	T ₂ [Nm]	P ₂ [kW]	n ₂ [rpm]	T ₂ [Nm]	P ₂ [kW]	n ₂ [rpm]	T ₂ [Nm]	P ₂ [kW]		
SL3001											
4.04				248	16362	424	124	20143	261	76000	
4.50				222	16609	387	111	20448	238	74000	
5.12		*		195	17067	349	98	21011	215	59000	
6.00				167	17528	306	83	20709	181	54000	
7.36				136	13696	195	68	14291	102	36000	
SL3002											
15.96	94	21760	214	63	24574	161	31.3	30255	99	76000	
17.86	84	22471	198	56	25378	149	28.0	31244	92	76000	
19.89	75	22969	181	50	25940	137	25.1	31224	82	74000	
22.77	66	23920	165	43.9	27014	124	22.0	31484	72	74000	
24.24	62	23751	154	41.3	26823	116	20.6	32776	71	76000	
27.00	56	25174	146	37.0	28430	110	18.5	31814	62	74000	38
30.72	48.8	23601	121	32.6	24195	82	16.3	25246	43.0	59000	
33.75	44.4	25273	118	29.6	25910	80	14.8	27035	41.9	58500	
38.40	39.1	23926	98	26.0	24529	67	13.0	25594	34.9	59000	
45.00	33.3	21906	76	22.2	22458	52	11.1	23433	27.3	54000	
SL3003											
55.85	26.9	31687	89	17.9	33061	62	9.0	34559	32.4	76000	
62.50	24.0	32472	82	16.0	33290	56	8.0	35151	29.4	76000	
71.55	21.0	32743	72	14.0	33568	49.1	7.0	35878	26.3	76000	
79.79	18.8	32963	65	12.5	33793	44.4	6.3	36474	23.9	76000	
93.57	16.0	33286	56	10.7	34125	38.2	5.3	37364	20.9	76000	25
105.0	14.3	33522	50	9.5	34366	34.3	4.8	38019	19.0	76000	
107.1	14.0	33564	49.2	9.3	34409	33.6	4.7	38137	18.6	76000	
122.7	12.2	33844	43.3	8.2	35051	29.9	4.1	38925	16.6	76000	
145.4	10.3	34199	36.9	6.9	35966	25.9	3.4	39942	14.4	76000	
162.0	9.3	33196	32.2	6.2	34812	22.5	3.1	38660	12.5	74000	
SL3004											
172.0	8.7	34697	31.7	5.8	36891	22.5	2.9	40969	12.5	76000	
195.5	7.7	35374	28.4	5.1	37611	20.1	2.6	41769	11.2	76000	
230.7	6.5	36271	24.7	4.3	38565	17.5	2.2	42828	9.7	76000	
261.3	5.7	36961	22.2	3.8	39299	15.7	1.9	42181	8.5	76000	
288.8	5.2	37524	20.4	3.5	39897	14.5	1.7	44308	8.0	76000	
330.0	4.5	38289	18.2	3.0	40711	12.9	1.5	45211	7.2	76000	
369.9	4.1	38956	16.5	2.7	41420	11.7	1.4	45999	6.5	76000	
414.6	3.6	39634	15.0	2.4	42141	10.6	1.2	46799	5.9	76000	
463.9	3.2	40314	13.7	2.2	42864	9.7	1.1	47602	5.4	76000	
518.7	2.9	41001	12.4	1.9	43594	8.8	0.96	48413	4.9	76000	
578.5	2.6	41682	11.3	1.7	44319	8.0	0.86	49218	4.5	76000	
647.3	2.3	42397	10.3	1.5	45079	7.3	0.77	50062	4.0	76000	17
741.0	2.0	43273	9.2	1.3	46010	6.5	0.67	51096	3.6	76000	
776.8	1.9	43583	8.8	1.3	46339	6.2	0.64	51462	3.5	76000	
889.2	1.7	44483	7.9	1.1	47297	5.6	0.56	52525	3.1	76000	
990.5	1.5	43056	6.8	1.0	45779	4.8	0.50	50839	2.7	74000	
1175	1.3	44180	5.9	0.85	46974	4.2	0.43	52166	2.3	74000	
1205	1.2	34413	4.5	0.83	36438	3.2	0.41	40465	1.8	59000	
1392	1.1	35170	4.0	0.72	37239	2.8	0.36	41356	1.6	59000	
1670	0.9	36154	3.4	0.60	38281	2.4	0.30	42512	1.3	59000	
1733	0.87	21604	2.0	0.58	22970	1.4	0.29	25509	0.8	36000	
1958	0.77	32996	2.6	0.51	35083	1.9	0.26	38961	1.0	54000	
2401	0.62	22696	1.5	0.42	24132	1.1	0.21	26799	0.6	36000	

(*)
 Consultare il Servizio Tecnico Brevini
 Please consult Brevini
 Wenden Sie sich an den Technischen Kundendienst Brevini
 Consulter le service technique Brevini
 Contacte con el Servicio Técnico de Brevini
 Consultar o Serviço Técnico da Brevini

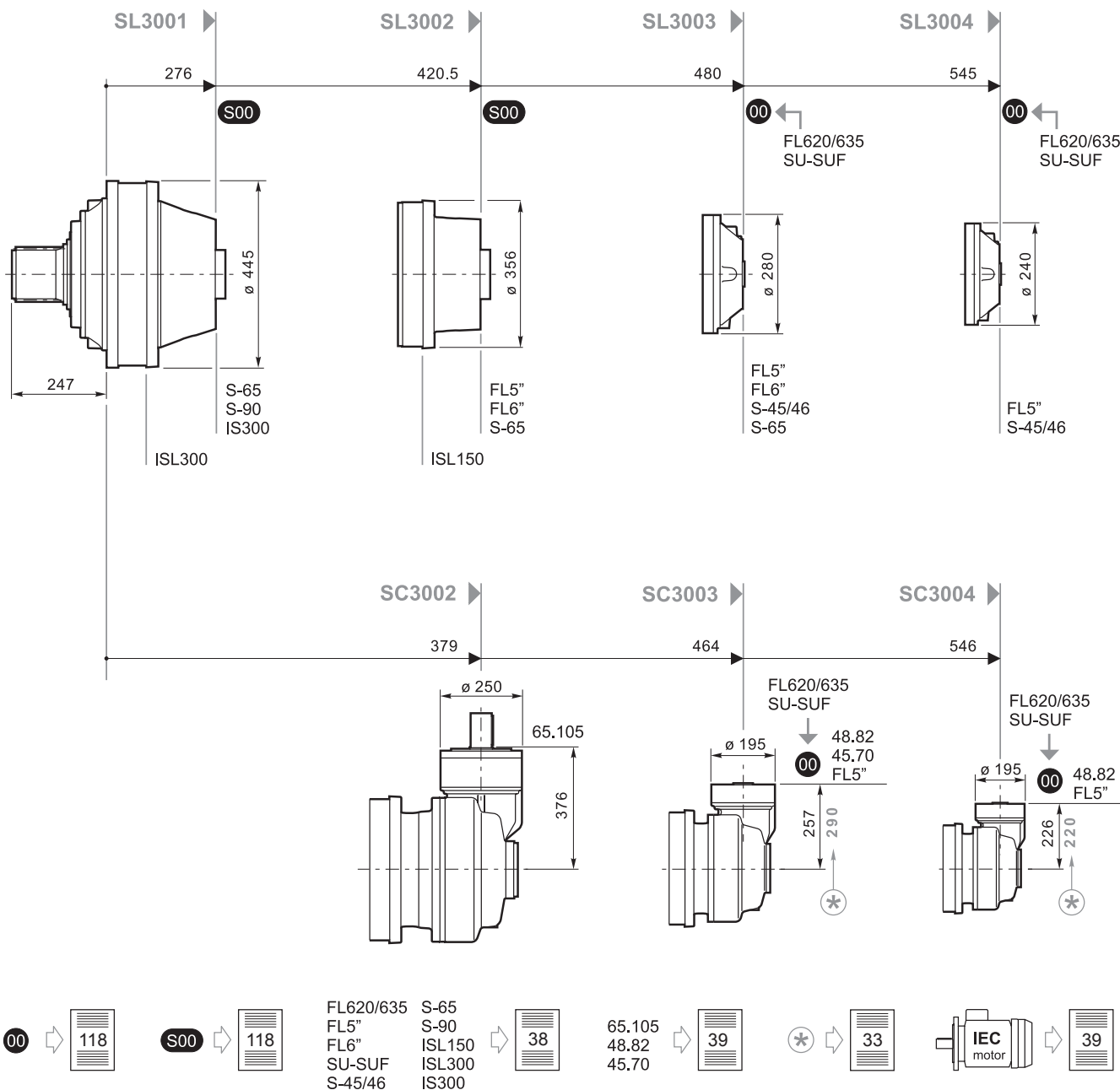
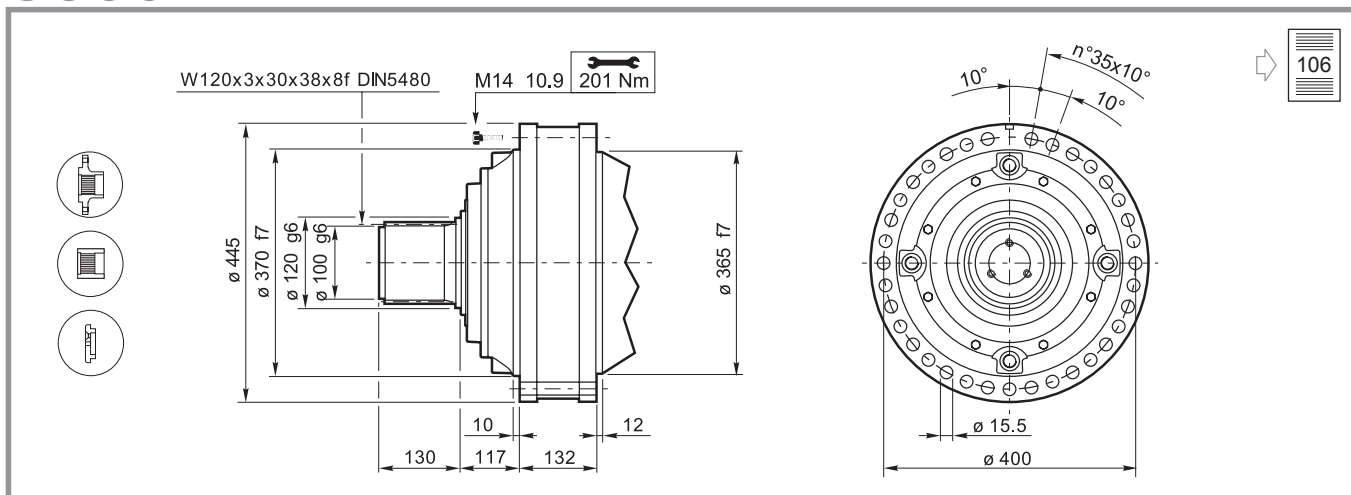

S300

S-45/46, S-65, S-90, ISL150, ISL300, IS300

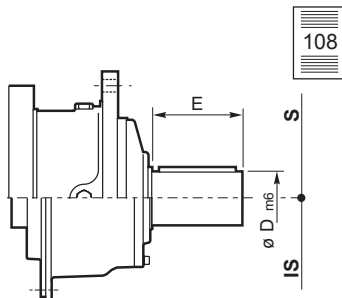

108

	S-45CR1	S-46C1	S-65CR1	S-90CR1	ISL150	ISL300	IS300
D m6	65	65	80	90	90	90	100
E	105	105	130	170	130	130	210
Lt (FE - FS)							
SL3001			460.5	466.5		325	446
SL3002			604.5		482.5		
SL3003	600	641	638.5				
SL3004	600	641					
Lt (MP - MP1)							
SL3001			468.5	474.5		333	454
SL3002			612.5		490.5		
SL3003	608	649	646.5				
SL3004	608	649					

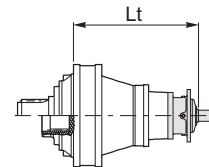

SU-SUF

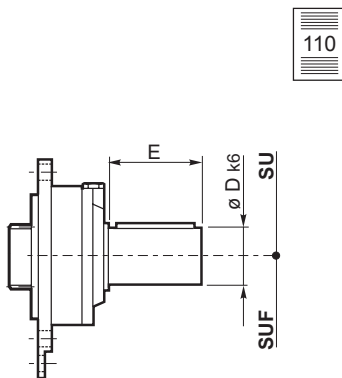

110

	SU/SUF.1	SU/SUF.2	SU/SUF.3
D m6	28	40	48
E	50	58	82
Lt (FE - FS)			
SL3003	533	533	533
SL3004	597	597	597
Lt (MP - MP1)			
SL3003	541	541	541
SL3004	605	605	605
Lt			
SC3003	317-350*	317-350*	317-350*
SC3004	286-280*	286-280*	286-280*

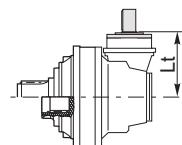
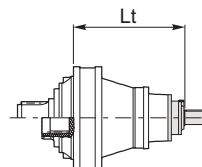

* 33

FL5", FL6"

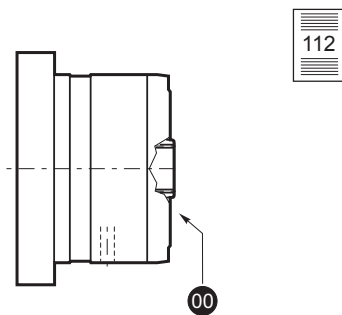

112

	FL250.4C FL250.6C	FL350.6C FL350.8C	FL450.6C FL450.8C	FL650.10C FL650.12C FL650.14C	FL750.10C FL750.12C FL750.14C	FL960.12C FL960.14C FL960.16C FL960.18C
Lt (FE - FS)						
SL3002	491.5	491.5	491.5	505	505	519
SL3003	577.5	577.5	577.5	591	591	605
SL3004	630.5	630.5	630.5	644	644	
Lt (MP - MP1)						
SL3002	499.5	499.5	499.5	513	513	527
SL3003	585.5	585.5	585.5	599	599	613
SL3004	638.5	638.5	638.5	652	652	
Lt						
SC3003	408.5-441.5*	408.5-441.5*	408.5-441.5*	422-455*	422-455*	
SC3004	377.5-280*	377.5-280*	377.5-280*	391-293.5*	391-293.5*	

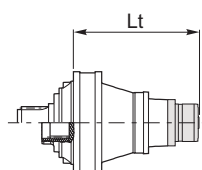

FL620/635

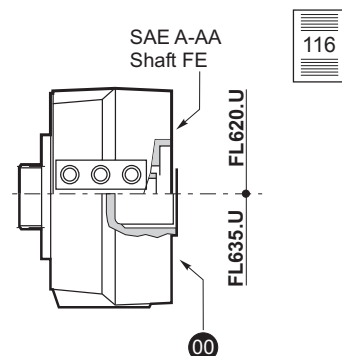

116

	FL620.U	FL635.U
Lt (FE - FS)		
SL3003	577.5	564.5
SL3004	641.5	628.5
Lt (MP - MP1)		
SL3003	585.5	572.5
SL3004	649.5	636.5
Lt		
SC3003	361.5-394.5	384.5-381.5
SC3004	330.5-324*	317.5-311.5*

* 33

