

**DUCA-LCD96**  
468001289

**DUCA-LCD96 485**  
468001291

**DUCA-LCD96-ETH**  
468001296

**DUCA-LCD96-PROFI**  
468001294

**DUCA-LCD96 485-RELE**  
468001293

**DUCA-LCD96 485-IO**  
468001292

**DUCA-LCD96 BASE**  
468001288

# NETWORK ANALYSER



Assembly and use instructions

DUCA-LCD96

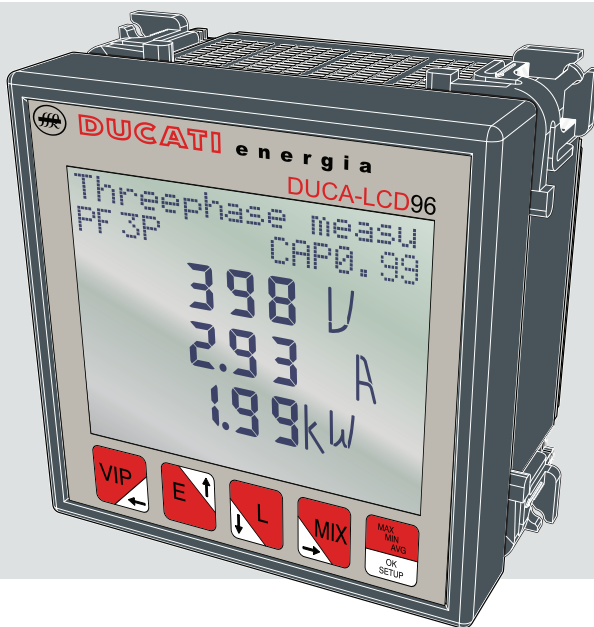

**DUCATI** energia



<b>1 GENERAL INFORMATION</b>	
1.1 Reference regulations and conformity.....	5
1.2 Use and storage of the manual.....	6
1.2.1 Storing.....	6
1.2.2 Copyright.....	6
1.3 General safety warnings.....	7
<b>2 PACKAGING CONTENTS</b>	
2.1 Removal of packaging.....	8
2.2 Description of the contents.....	9
<b>3 TECHNICAL CHARACTERISTICS</b>	
3.1 Description of the device.....	10
3.2 Measuring functions.....	10
3.3 Models.....	11
3.4 Overall dimensions.....	12
3.5 Technical data.....	13
<b>4 INSTALLATION</b>	
4.1 Assembly.....	18
4.2 Disassembly.....	19
4.3 Connections.....	20
4.3.1 Inputs connections.....	22
4.3.2 Optional outputs connections.....	24
4.4 Configurations for first use.....	26
<b>5 OPERATING</b>	
5.1 Front panel.....	27
5.2 Use of device.....	29
5.2.1 Access to the page.....	30
5.3 Configuration of the SETUP device.....	31
5.3.1 Control keys.....	32
5.3.1.1 Data entry.....	33
5.3.2 Password menu.....	34
5.3.2.1 Password creation.....	34
5.3.2.2 Password modification.....	35
5.3.2.3 Password entry.....	35
5.3.3 Reset menu.....	37
5.3.4 Configuration menu.....	38
5.3.4.1 Type of entry.....	38
5.3.4.2 Set CT ratio.....	40
5.3.4.3 Set VT ratio.....	41
5.3.4.4 Average time.....	42
5.3.4.5 Current threshold for T2 hour counter.....	42
5.3.4.7 Generation.....	44
5.3.4.8 Euro/energy factor.....	45
5.3.4.9 CO2/energy factor.....	45
5.3.4.10 Back lighting.....	46
5.3.4.11 Energy saving.....	46
5.3.5 Digital output menu.....	47
5.3.5.1 Digital output mode.....	47

5.3.5.2	Energy value for pulse.....	48
5.3.5.3	Alarm1 or alarm2(*) parameter.....	49
5.3.5.4	Alarm 1 or 2 threshold.....	50
5.3.5.5	Alarm 1 or 2 activation.....	50
5.3.5.6	Alarms 1 or 2 activation delay.....	51
5.3.5.7	Alarm 1 or 2 hysteresis.....	51
5.3.6	Alarm output menu.....	52
5.3.6.1	Alarm 3 or 4 parameter (*).....	52
5.3.6.2	Alarm 3 or 4 threshold.....	53
5.3.6.3	Alarm 3 or 4 activation.....	53
5.3.6.4	Alarms 3 or 4 activation delay.....	54
5.3.6.5	Alarm 3 or 4 hysteresis.....	54
5.3.7	I/O card menu.....	55
5.3.7.1	Outputs span.....	55
5.3.7.2	Output 1 parameter.....	56
5.3.7.3	Output 2 parameter.....	56
5.3.7.4	Input pulses factors.....	57
5.3.7.5	External synchronism.....	57
5.3.7.6	Output associated parameter table.....	58
5.3.8	Communication menu.....	59
5.3.8.1	PROFIBUS address (only DUCA-LCD96-PROFI).....	59
5.3.8.2	Serial protocol.....	60
5.3.8.3	Address.....	60
5.3.8.4	Baud rate.....	61
5.3.8.5	Parity type.....	61
5.3.8.6	Number of stop bits.....	62
5.3.8.7	DHCP (only DUCA-LCD96 ETH).....	62
5.3.8.8	IP Address (only DUCA-LCD96 ETH).....	63
5.3.8.9	Host name (only DUCA-LCD96 ETH).....	63
5.3.9	Language menu.....	64
5.3.10	Self-diagnosis menu.....	65
5.3.11	Info menu.....	66
5.3.12	SETUP mode exit.....	66
5.3.13	Setup parameters table and factory settings.....	67
<b>5.4</b>	<b>Data reading.....</b>	<b>69</b>
5.4.1	Default page setting.....	69
5.4.2	Voltages, Currents and 3-phase powers.....	70
5.4.3	Energies.....	71
5.4.4	Voltage, Currents and single phase 3-phase Powers.....	73
5.4.5	THDF, Alarms, Timer and input pulses.....	74
5.4.6	Maximums.....	76
5.4.7	Minimums.....	77
5.4.8	Averages.....	78
5.4.9	Maximum demand.....	78
<b>6</b>	<b>TROUBLESHOOTING</b>	
6.1	Problems, causes, solutions.....	79
6.1.1	Error codes.....	80



# 1 GENERAL INFORMATION

## 1.1 Reference regulations and conformity

Electrical safety	2006/95/CEE 93/68/CEE (Low-Voltage Directive).  IEC 61010-1
Electromagnetic compatibility	89/336/CEE
Use of hazardous substances	UE 2002-95-CE – RoHS
Measuring instruments	IEC 60688 IEC 61326-1 IEC 62053-21 IEC 62053-23 IEC 62053-31
Degree of protection	IEC 60529
Standardised dimensions for the panel	IEC 61554

## 1.2 Use and storage of the manual



Carefully read this manual and adhere to the indications described prior to using the device.

This manual contains all of the safety information, the technical aspects and the operating necessary to ensure the correct use of the device and maintain it in safe conditions.

### 1.2.1 Storing

The manual must be stored close to the device; safe from liquids and anything else which may compromise its legibility.

The manual and the declaration of conformity are both an integral part of the device until it is dismantled.

If the manual is lost or illegible please request a copy from the manufacturer.

### 1.2.2 Copyright

**The copyright of this manual is the property of DUCATI Energia S.p.A.**

This manual contains texts, designs and illustrations of a technical nature which must not be disclosed or transmitted to third parties, even partially, without the written authorisation of DUCATI Energia S.p.A.

### 1.3 General safety warnings



**Non-adherence to the following points can lead to serious injury or death.**

**NE**

- Use the suitable personal protection devices and adhere to the current regulations governing electrical safety.
- **This device must be installed exclusively by qualified personnel who have read all of the information relative to the installation.**
- Check that the voltage supply and measurement are compatible with the range permitted by the device.
- Ensure that all current and voltage supplies are disconnected prior to carrying out any controls, visual inspections and tests on the device.
- Always assume that all circuits are under voltage until they are completely disconnected, subjected to tests and labelled.
- Disconnect all of the power supply prior to working on the device.
- Always use a suitable voltage detection device to check that the supply is interrupted.
- Pay attention to any dangers and carefully check the work area ensuring that no instruments or foreign objects have been left inside the compartment in which the device is housed.
- The correct use of this device depends on a correct manipulation, installation and use.
- Failure to adhere to the basic installation information can lead to injuries as well as damage to the electric instruments or to any other product.
- NEVER connect an external fuse in by-pass.
- Disconnect all of the input and output wires before carrying out a dielectric rigidity test or an insulation test on an instrument in which the device is installed.
- The tests carried out at a high voltage can damage the device's electronic components.

## 2 PACKAGING CONTENTS

EN

### 2.1 Removal of packaging



We recommend that the packaging is stored in a suitable location in compliance with the warranty terms

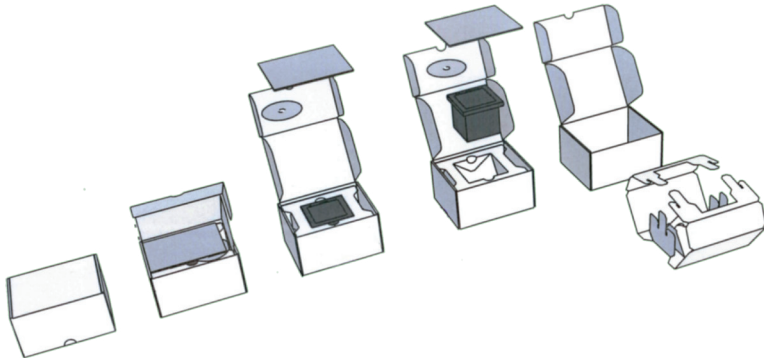

## 2.2 Description of the contents

The packaging includes:

- 1) network analyser
- 2) user manual
- 3) calibration certificate
- 4) mini CD with technical documentation
- 5) assembly accessories



Prior to using the product read the documentation attached and strictly adhere to the indications provided.

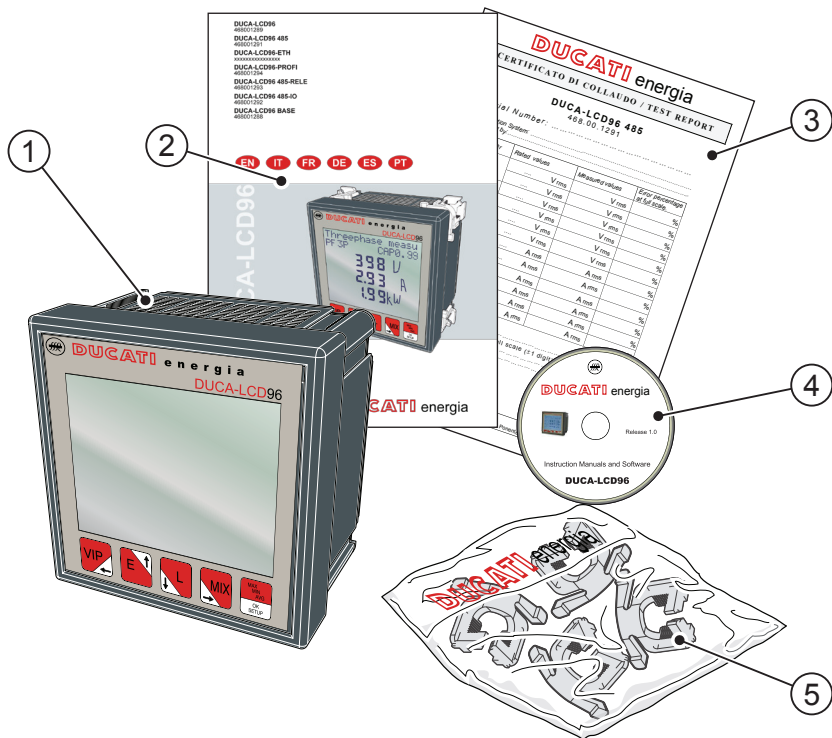

### DUCA-LCD96

NETWORK ANALYSER

## 3 TECHNICAL CHARACTERISTICS

NE

### 3.1 Description of the device

The **DUCA-LCD96** network analyser is an instrument that measures of the main electric quantities on 3-phase and monophasic networks designed for the monitoring and the local or remote analysis of:

- electrical parameters of systems in low or medium voltage;
- system energy consumption.

### 3.2 Measuring functions

All of the DUCA-LCD96 series models are able to measure and process the quantities shown below.

- 1) Voltages (phase neutral and linked) and relative peak values;
- 2) Currents and relative peak values;
- 3) Active, reactive and apparent phase powers and the 3-phase system on 2 and 4 quadrants;
- 4) Power factors or PF phases and the 3-phase system, with distinction icon between the inductive and capacitive load;
- 5) Frequency (measured on L1-N phase);
- 6) Active, reactive and apparent phase energies and the 3-phase system on 2 quadrants (with automatic recognition function of the AT directions);
- 7) Active, reactive and apparent power phases and the 3-phase system on 4 quadrants (monitoring of energy absorbed and generated by the system);
- 8) Average power values on a time period programmed by the user;
- 9) Maximum calculated demand on active and apparent power;
- 10) Voltage and current THdF expressed in absolute and percent values;
- 11) T1 increase total operating hour counter and T2 decrease partial hour counter;
- 12) Balance of active, reactive and apparent energy of 3-phase system, balance = absorbed energy - generated energy;
- 13) Balance of the "partial" active, reactive and apparent energies of the 3-phase system on 4 quadrants in a period that can be programmed by the user, balance = energy absorbed - energy generated;



The change frequency (for each quantity available on display) is equal to 2 times/second.

### 3.3 Models

Models	Inputs and outputs	Serial communication protocol
<b>DUCA-LCD96</b>	2 outlets programmable with pulses or threshold alarms	
<b>DUCA-LCD96 485</b>	2 outlets programmable with pulses or threshold alarms	Modbus RTU
<b>DUCA-LCD96-ETH</b>	2 outlets programmable with pulses or threshold alarms	Modbus TCP/IP
<b>DUCA-LCD96-PROFI</b>	2 outlets programmable with pulses or threshold alarms	Profibus DP
<b>DUCA-LCD96 485-RELE</b>	2 electromechanical relays 16A AC1 - 3A AC15 2 outlets programmable with pulses or threshold alarms	Modbus RTU
<b>DUCA-LCD96 485-IO</b>	2 analog outputs 4 -20 mA 3 inputs for external pulse reading 2 outputs programmable as pulses or threshold alarms	Modbus RTU
<b>DUCA-LCD96 BASE</b>	2 outlets programmable with pulses or threshold alarms. Current inputs through Shunt	

All of the models have the following in common:

- multivoltage supply voltage;
- multilanguage display with scrolling text;
- self-diagnosis function for the installation control;
- setting of a safety password;
- T1 and T2 hour counter.

**3.4 Overall dimensions**

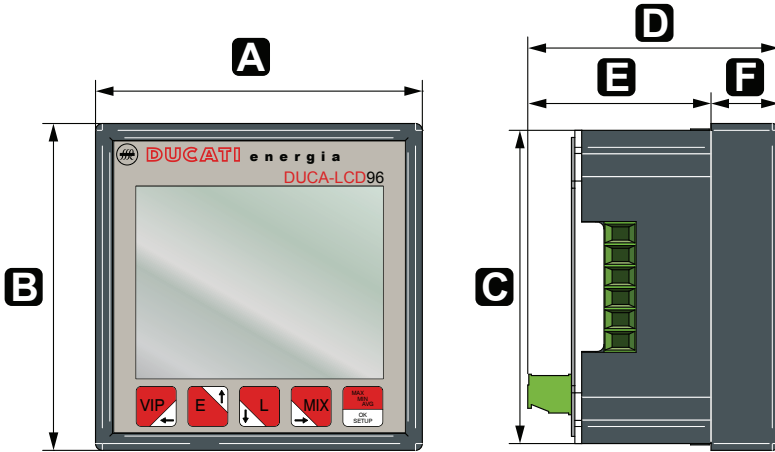

<b>A</b> 96 mm	<b>D</b> 77 mm
<b>B</b> 96 mm	<b>E</b> 57 mm
<b>C</b> 92 mm	<b>F</b> 20 mm

<b>IEC 61554</b>	
<b>X</b>	92 <sup>-0+0,8</sup> mm
<b>Y</b>	92 <sup>-0+0,8</sup> mm

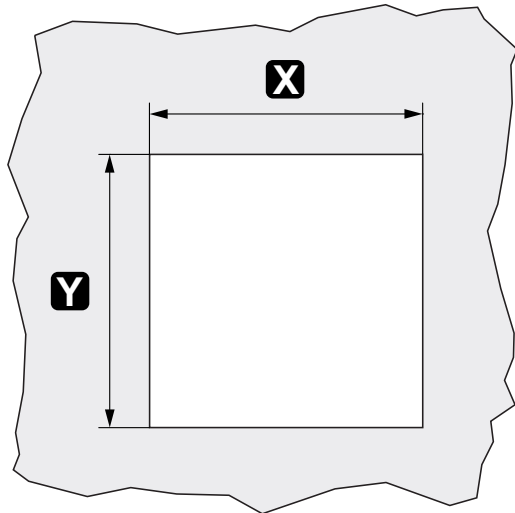



### 3.5 Technical data

Auxiliary power supply		
Voltage interval	[V]	from 24 to 240 a.c./d.c. from 48 to 240 a.c./d.c. DUCA-LCD96-ETH, DUCA-LCD96-PROFI, DUCA-LCD96 485-IO
Frequency interval	[Hz]	45 ÷ 65
Protection fuse		T 0.5 A

<b>Power consumption</b>	[VA]	13 max
--------------------------	------	--------

<b>Measurement type</b>	Sampling TRMS
-------------------------	---------------

Measurement accuracy		
Voltage		±0.5% F.S. ±1 digit
Outlet current		±0.5% F.S. ±1 digit
Frequency	[Hz]	40.0 ÷ 99.9: ±0.2% ±0.1 100 ÷ 500: ±0.2% ±1
Power factor		±1% ±1 digit (from cosΦ= 0,3 Inductive to cosΦ= 0,3 Capacitive)
Active power		±1% ±0,1% F.S (from cosΦ= 0,3 Inductive to cosΦ= 0,3 Capacitive)
Active energy		Class 1

Measurement interval		
Voltage	[V]	from 0 to 500 a.c. TRMS VL-N Display with 0 decimals
Outlet current		from 50 mA to 5 A TRMS Display in A with 2 decimals
Frequency	[Hz]	from 40 to 500 Visualisation: with 1 decimal up to 99.9 with 0 decimals above 100
Power factor		Display with 2 decimals

Installation		
Distribution networks		Low and medium voltage Monophase insertion 3-phase with neutral 3-phase without neutral
Amperometric inputs	[A]	Always use external TA Primary from 1 to 10.000 A a.c. approx. Secondary 5 A and 1 A a.c. approx. Note: in case of AT secondary at 1 A the accuracy class is declassified to 2.5% F.S. $\pm 1$ digit, in range 5%-100% F.S.
		Direct insertion up to 500 a.c. approx. Indirect insertion with VT: Primary from 60 to 60,000 A a.c. approx. secondary from 60 to 190 V a.c. Note: in case of VT secondary at 1 A the accuracy class is declassified to 2.5% F.S. $\pm 1$ digit, in range 5%-100% F.S.
Voltmetric inputs	[V]	Direct insertion up to 500 a.c. approx. Indirect insertion with VT: Primary from 60 to 60,000 A a.c. approx. secondary from 60 to 190 V a.c. Note: in case of VT secondary at 1 A the accuracy class is declassified to 2.5% F.S. $\pm 1$ digit, in range 5%-100% F.S.
Protection fuse	[A]	0.1

<b>Data change frequency</b>	2 volts/second
------------------------------	----------------

<b>Harmonic distortion count</b>	[Hz]	Band measurement up to 500
----------------------------------	------	----------------------------

Energy measurement	
Single phase maximum value counted	10 GWh / GVarh / GVAh
3-phase maximum value counted	30 GWh / GVarh / GVAh
Energy balance maximum value counted	10 GWh / GVarh / GVAh with sign
Input pulses maximum energy value counted	40 GWh / GVarh
Minimum quantum of energy that can be displayed (by means of display or through communication interfaces)	10Wh / 10VArh / 10VAh

Terminal characteristics	
Amperometric inputs	Section 6 mm <sup>2</sup> - Step 6.35 mm
Voltmetric inputs	Section 2.5 mm <sup>2</sup> - Step 7.62 mm
Impulsive outputs	Section 2.5 mm <sup>2</sup> - Step 5.08 mm
RS485 Serial port	Section 2.5 mm <sup>2</sup> - Step 5.08 mm
Relay outputs	Section 2.5 mm <sup>2</sup> - Step 5.08 mm

Overall dimensions
96 mm x 96 mm x 77 mm (Depth inside control box: 57 mm)

Weight	[Kg]	0.400 max

Standard normatives	
Overall dimensions	IEC 61554
Protection degree	IEC 60529
Accuracy class	IEC 60688, IEC 61326-1, IEC 62053-21 , IEC 62053-23, IEC 62053-31.
Electrical safety	IEC 61010-1

User interface	
Display	Scrolling text in diverse languages to be selected by user.
Display type	LCD with back lighting which can be set by user
Display dimensions	[mm] 72x57

Communication interface	
RS485	
Protocol	Modbus RTU or ASCII Ducati
Electric standard	RS485 with optical isolation
Baud rate	4.8, 9.6, 19.2 kbps
Parity number	Odd, Even, None
Stop bit	1, 2
Address	1-247 for Modbus RTU; 1-98 for Ducati ASCII
Connectors	4 pole terminal (integrated 120 Ohm termination on T terminal)

<b>Profibus</b>	
Protocol	Profibus with slave DP-V0 function in compliance with IEC 61158 regulations
Electric standard	RS485 with optical isolation
Baud rate	Automatic detection [9.6 - 12 Mbps]
LED indicators	Green for communication status and Red for communication error
Address	1 -126
Connectors	DB 9 female connector (do not use connectors with 90° cable outlet)
<b>Ethernet</b>	
Protocol	Modbus TCP/IP
Connectors	RJ45 MDI/MDX auto crossover

<b>Digital output programmed as pulse</b>		
Contact supply external voltage	[V]	48 max (peak ac/dc)
Maximum current	[mA]	100 (peak ac/dc)
Pulse duration	[ms]	50 OFF (min) / 50 ON closed contact
Pulse frequency		10 pulses/s (max)

<b>Digital output programmed as alarm</b>		
Contact supply external voltage	[V]	48 max (peak ac/dc)
Maximum current	[mA]	100 (peak ac/dc)
Alarm activation delay	[s]	1 - 900 s (programmable)
Alarm return hysteresis		0 - 40% (programmable)

<b>Relay outputs</b>	
Rated current	[A] 16 AC1 - 3 AC15
Max. instant current	[A] 30
Rated voltage	[V] 250 ac
Max instant voltage	[V] 400 ac
Nominal load	[VA] 4000 AC1 - 750 AC15

<b>Analog output</b>	
Settable electric parameters	Span [0 - 20 mA or 4 - 20 mA]
Dimmed	typical 250 Ohm, max 600 Ohm

Digital inputs		
Rated voltage	[V]	24 d.c. (absorption = 13 mA)
Max. voltage	[V]	32 d.c. (absorption = 22 mA)
Max. voltage for OFF state	[V]	8 d.c.
Min. voltage for ON state	[V]	18 d.c.

Hour counters	
Count-down timer	Count of the system operating time through the activation of a programmable threshold on total current. Upon expiry of the maintenance period set an icon will appear on the display.
Count-up timer	Life time of instrument

Climatic conditions		
Storage	[°C]	from -10 to +60
Use	[°C]	from -5 to +55
Relative humidity		Max 93% (without condensation) at 40°C

Protection degree	
Frontal	IP50
At terminals	IP20

## 4 INSTALLATION

EN

### 4.1 Assembly

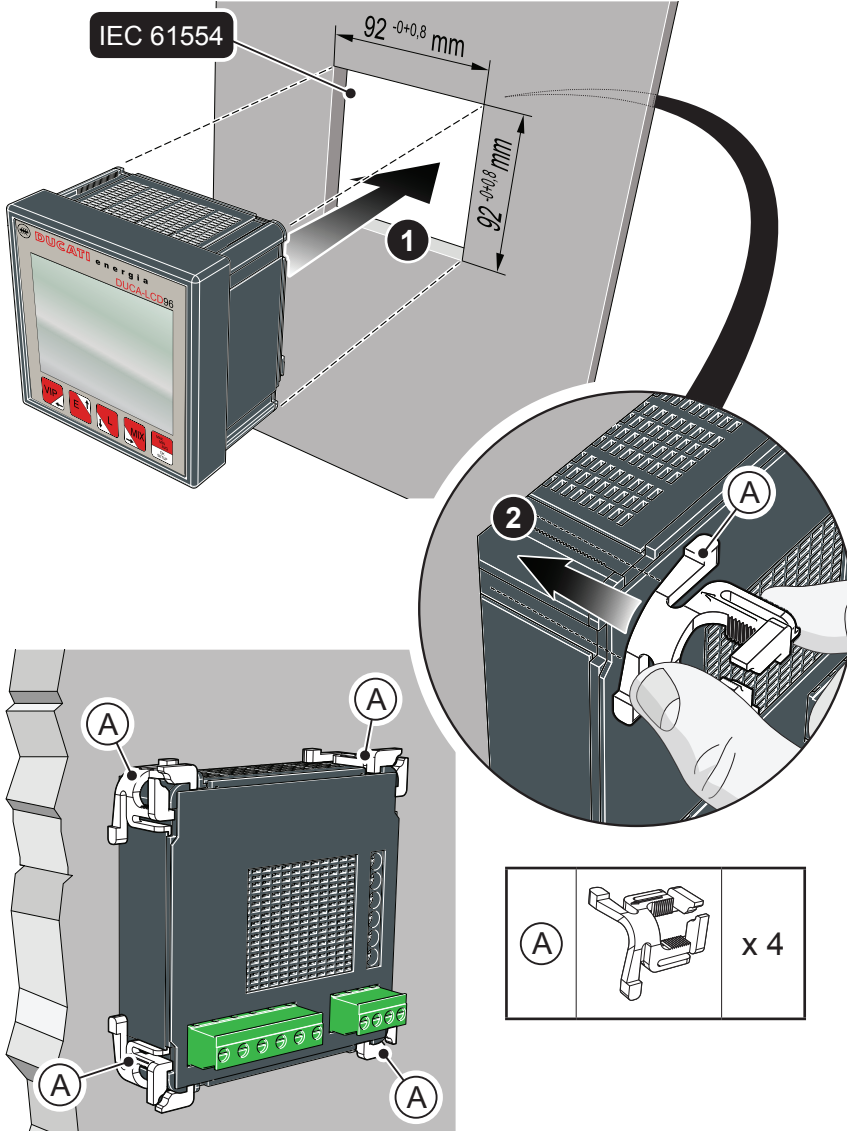

## 4.2 Disassembly

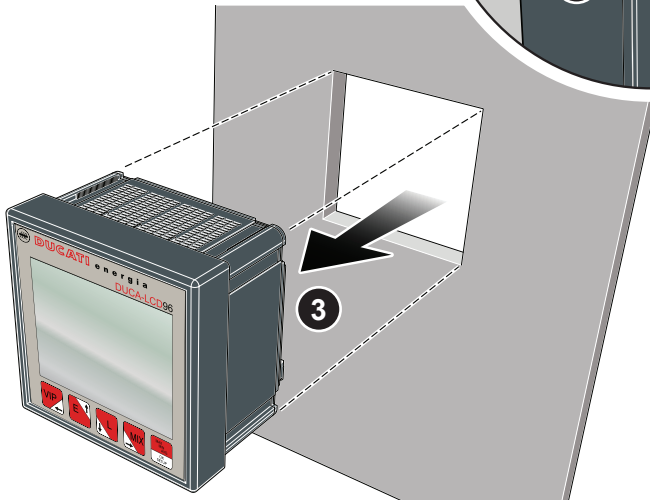
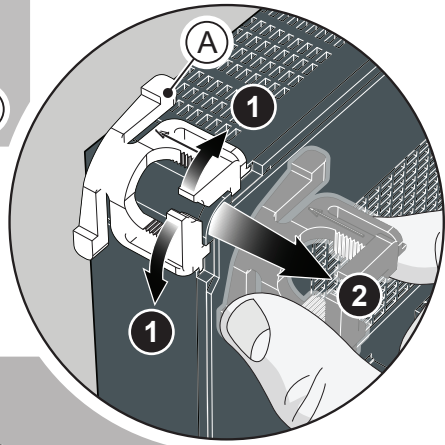
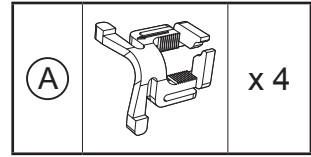
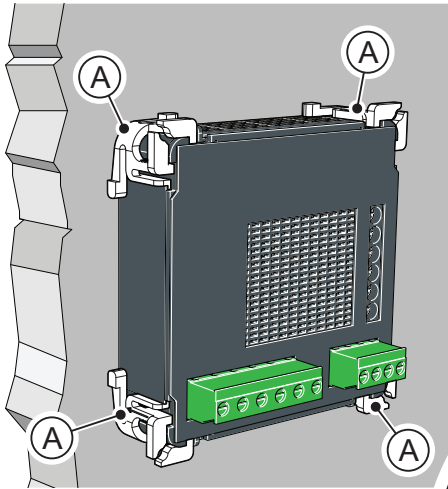

**DUCA-LCD96**

NETWORK ANALYSER

### 4.3 Connections

The operations to carry out for the correct connection of the device, based on the type of electric line available, are described in this section.

EN



**The installation and the cabling of the device must be carried out by qualified personnel.**



**Danger of electrocution, burning and electric arc. Use the personal protection devices suitable to adhere to the current regulations governing electrical safety. Prior to carrying out any connections check the sectioning of the electric supply with the voltage detection device.**



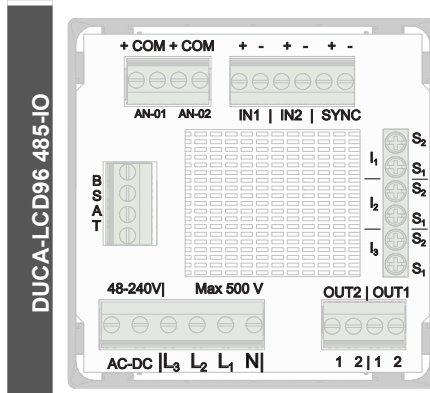
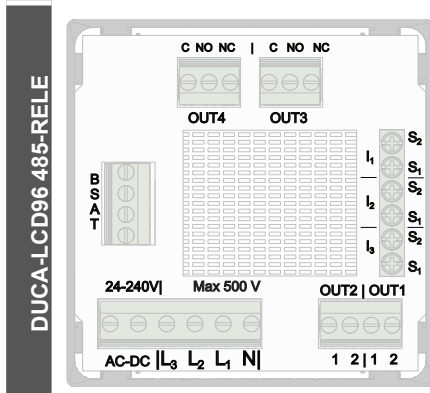
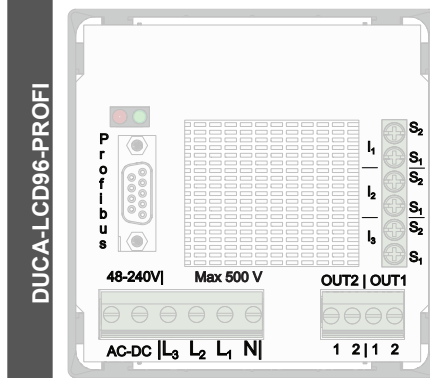
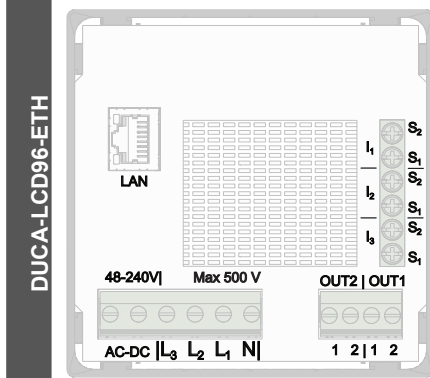
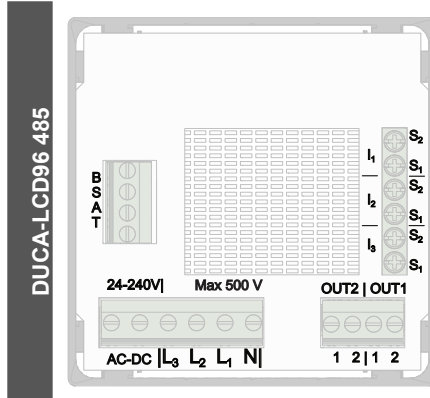
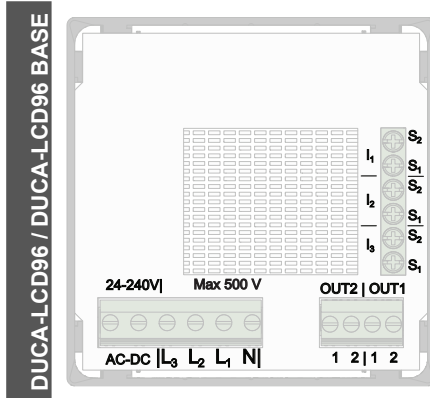

**DUCA-LCD96**

**4.3.1 Inputs connections**

**NE**

**1** 3-phase + neutral with 3 AT

**3** 3-phase + neutral with 3 AT and 3 VT

**2** 3-phase with 3 AT

**A** Fuse

**B** Dimmed

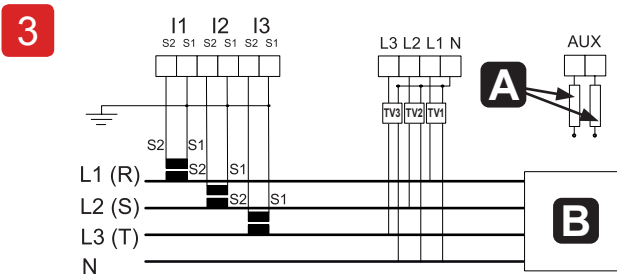
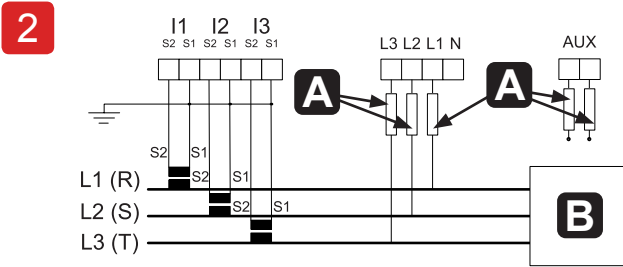
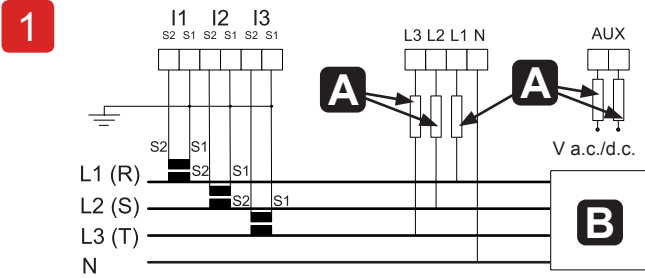



**4** AARON 3-phase with 2 AT and 3 VT

**6** Balanced 3-phase with 1 AT

**5** Monophase with 1 AT

**A** Fuse

**B** Dimmed

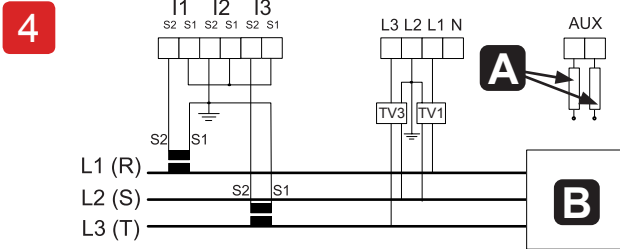

**!** Not suitable for the DUCA-LCD96 BASE model.

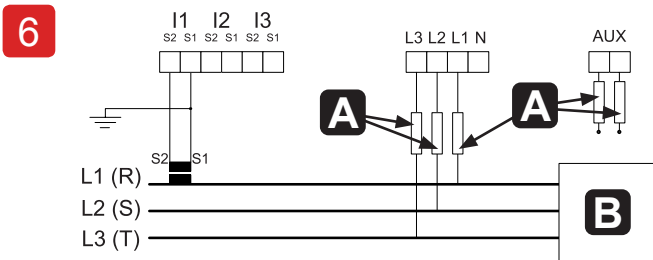
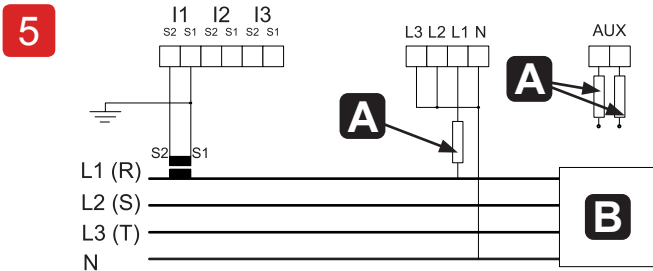

**4.3.2 Optional outputs connections**

**NE**

**7** Digital outlets as alarms with external relay for loads command

**8** Digital outputs as pulses

**9** Electromechanical relay outputs  
DUCA-LCD96 485-RELE

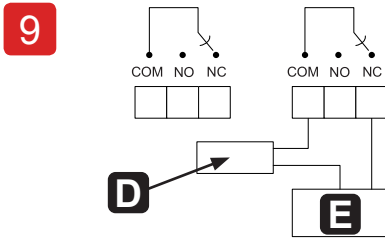
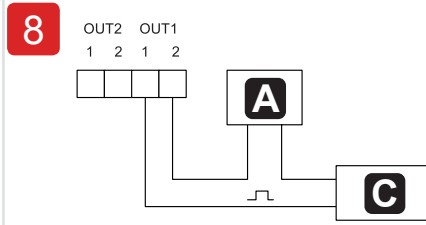
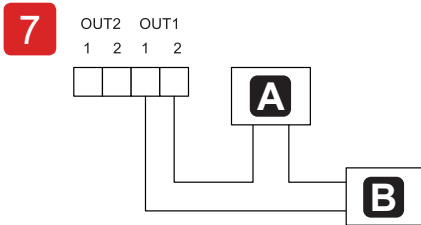

**A** V aux 48 V a.c./d.c. 100 mA

**D** Load 16A AC1 - 3AAC15

**B** External relay

**E** V aux 250 V a.c. MAX

**C** Pulse acquisition

**10** DUCA-LCD96 485-IO digital inputs  
(example in NPN mode)

**12** RS485

**11** Analog output DUCA-LCD96 485-IO

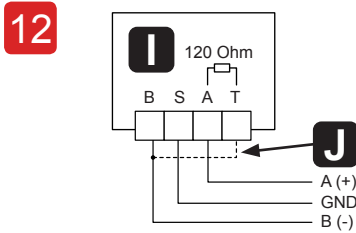
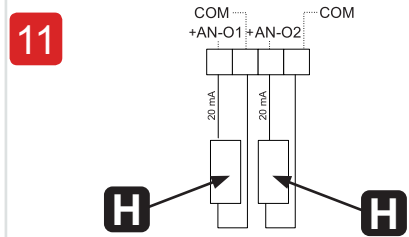
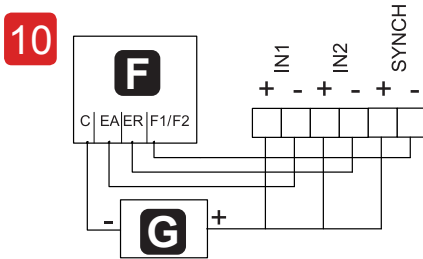

**F** G.M.C. + ES card

**I** Analyser

**G** V aux 24 V a.c./d.c. (32 V d.c. max)

**J** Termin. 120 Ohm

**H** Typical 250 Ohm load, max 600 Ohm

## 4.4 Configurations for first use

After having cabled the instrument according to the pre-selected layout, the following operations must be carried out to start to use the analyser:

- 1) set the language (see paragraph [“5.3.9 Language menu”](#))
- 2) set the CT transformation ratio (see [“5.3.4.2 Set CT ratio”](#))
- 3) set the VT transformation ratio (see [“5.3.4.3 Set VT ratio”](#))

## 5 OPERATING

### 5.1 Front panel

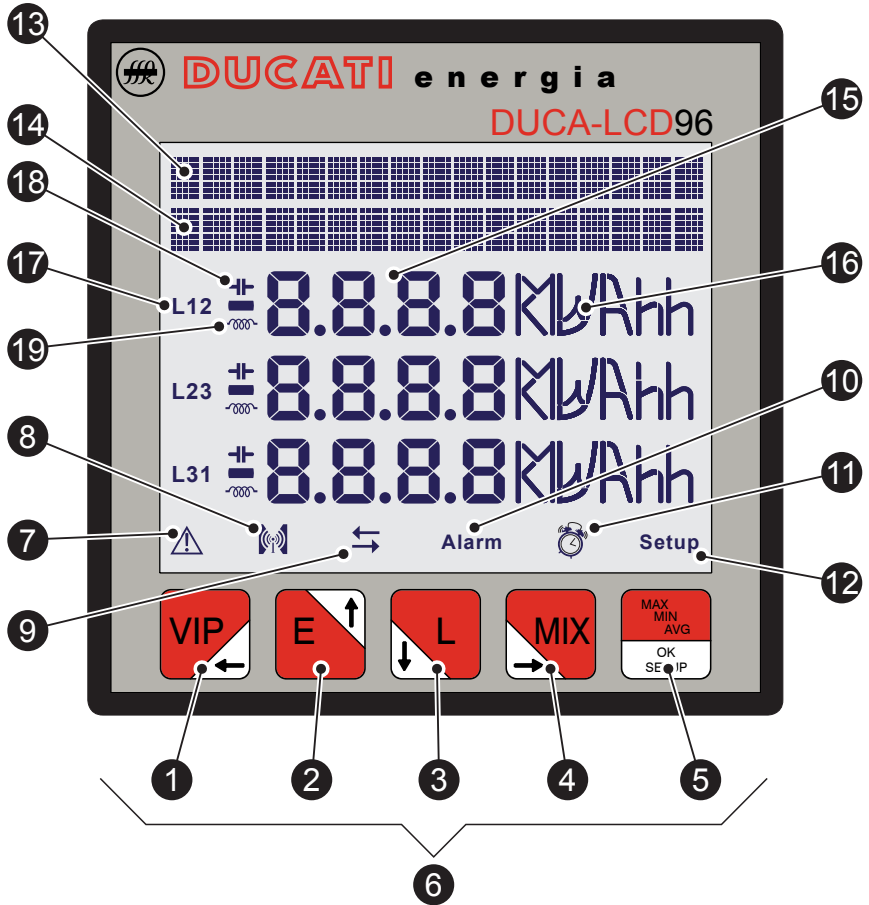

	Description
1	Control key 1
2	Control key 2
3	Control key 3
4	Control key 4
5	Control key 5
6	Control keys unit
7	Device error or warning indicator
8	Data transmission to external devices indicator
9	Indicator for data acquisition on 4 quadrants-GENERATION
10	Alarm indicators
11	Hours counter indicator
12	SETUP mode indicator
13	Scrolling descriptive text
14	Descriptive or data display text
15	Size reading values
16	Measurement unit
17	Line indicator corresponding to value displayed
18	Indicator of capacitive load (PF and reactive power page)
19	Indicator of inductive load (PF and reactive power page)



## 5.2 Use of device

During normal operating or during the reading of the parameters, the device is set in DATA READING mode.

During the configuration phase of one or more parameters the device will pass on to the SETUP mode (signalled on display by the **12** icon).

Based on the mode activate, the control keys **6** perform a specific function.



Passing from the DATA READING to SETUP mode and viceversa occurs by keeping the **5** key pressed down for over 2 seconds.



If the **7** icon is active when switching on, the device is signalling an installation or internal electronic anomaly. See paragraphs [“5.3.10 Self-diagnosis menu”](#) and [“6.1 Problems, causes, solutions”](#) to check the anomaly and solve the problem.

### 5.2.1 Access to the page

The device page is accessed by pressing, in sequence, the control keys **6**. The following layout explains how to correctly interpret the symbology used in this chapter.

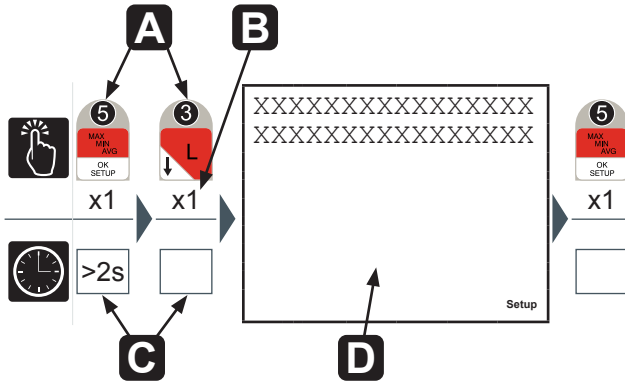

<b>A</b>	Control key sequence
<b>B</b>	Number of times to press the control key
<b>C</b>	How long to press the control key for
<b>D</b>	Page shown after having carried out the sequence in point A

EN

### 5.3 Configuration of the SETUP device

To access the SETUP device configuration menu press the **5** key for more than 2 seconds.

The display order of the main page of the menu and the relative configurations are illustrated in the following table:

Menu	Function
Password	Insertion, modification and disabling of device protection password.
Reset	Reset the peak/average, energy, hour counter values and reset the factory setting.
Configurations	Device configurations (electric network, back lighting, conversion factors, etc.)
Digital output	Digital output configurations.
Alarm outputs	DUCA-LCD96 485-RELE alarm output configuration
I/O card	Analog output configuration and digital inputs for DUCA-LCD96 485-IO pulses reading.
Communications	Communication module configurations
Language	Language selection.
Self-diagnosis	Insertion control and device status.
Info	Display of device identifying data
Exit	Return to normal DATA READING navigation.



**The device returns to the normal DATA READING navigation automatically if it remains waiting for over 3 minutes after any of the keys have been pressed.**





Repeatedly press the **1** key to reach the Exit page, regardless of navigation point. Press the **5** key to confirm.

**NE**

To quickly return to the normal DATA READING navigation, keep the **5** key pressed down for more than 2 seconds.

### 5.3.1 Control keys

In the SETUP mode, the control keys **6** allow the navigation and/or insertion of data between the different device configuration pages.

Key	Function
	Return to an advanced level menu or cancel the current modification in the data entry phase
	Ascending navigation of the page or increase of a data in data entry phase
	Descending navigation of the page or decrease of a data in data entry phase
	Change to field further to the right in data entry phase
	Access to an advance menu level or confirmation of a data in data entry phase

### 5.3.1.1 Data entry

Some of the pages require the entry of alphanumeric characters (A-Z, 0-9) in the SETUP mode.

In these cases the page will have a series of fields where the active field will be identified by a flashing cursor.

The data entry procedure (password, etc) is as follows:

- 1) Use the **2** and **3** keys to scroll the alphanumeric characters available in either ascending or descending order until the required character is obtained;
- 2) Use the **4** key to move the cursor between the characters;
- 3) Repeat the operations described in points 1 and 2 up to the completion of all the fields on the page;
- 4) Press the **5** key to confirm or the **1** key to cancel the modification...

5.3.2 Password menu

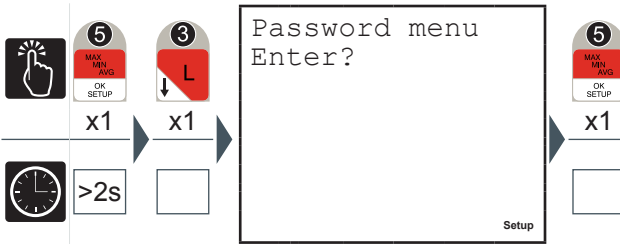

The entry, convalidation, modification and disabling of the device protection password operations can be carried out in this menu.

5.3.2.1 Password creation

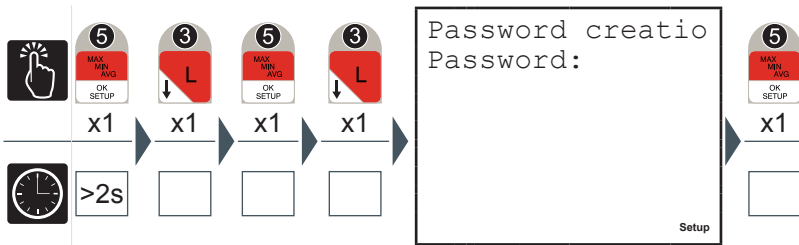

- 1) Enter the new password (see paragraph "5.3.1.1 Data entry").
- 2) When the entry is completed a page will appear for a few seconds to confirm the modification which has taken place.



In the session subsequent to the setting of the password all of the menus will be protected and in "reading only" mode.

5.3.2.2 Password modification

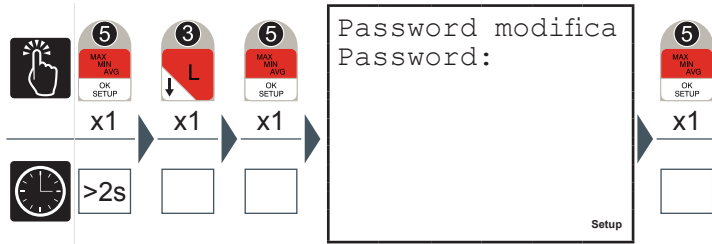

- 1) Modify the password (see paragraph "5.3.1.1 Data entry").
- 2) When the entry is completed a page will appear for a few seconds to confirm the modification which has taken place.



To disable the password set the value 0000.

5.3.2.3 Password entry

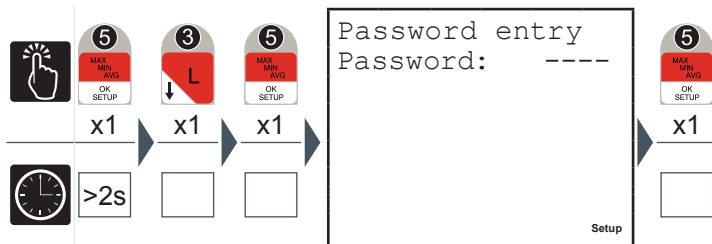

The password entry page does not appear if the password has not been previously set.

To avoid unauthorised persons intervening in the device configurations parameters, the access to a number of pages, in SETUP mode, requires the entry of a password (if set).

**NE**

At the password entry request, go to the Password entry page in the Password entry menu and continue as follows:

- 1) Press the **5** key

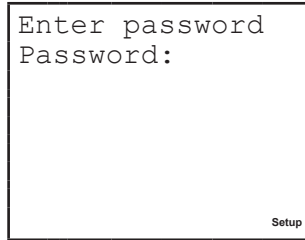

- 2) Insert the password (see paragraph [“5.3.1.1 Data entry”](#)).

If the password is entered incorrectly the following error will be shown

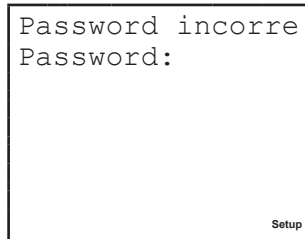

and the device will automatically return to the advanced menu level.



The correct entry of the password enables the modification of all of the parameters for the duration of the configuration session.



### 5.3.3 Reset menu

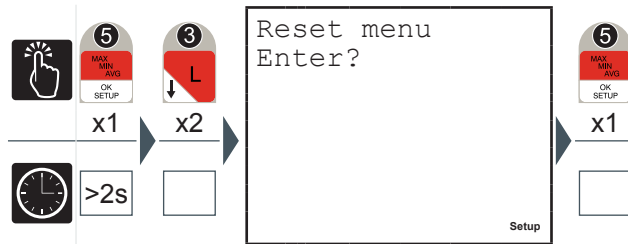

The following operations can be carried out in this menu:

- *Peaks reset*, the maximum, minimum and Maximum demand values are zeroed
- *Average values reset*
- *Timer reset*: T1 is zeroed, T2 starts from the value set
- *Balance reset* partial of energy
- *Energy reset*, all of the energy counts are zeroed, including the counts from external impulses for DUCA-LCD96 485-IO
- *Total reset*: resetting of the factory settings for all of the setup parameters

- 1) With the **2** or **3** keys select the page corresponding to the value you wish to reset.
- 2) Press the **5** key to confirm.

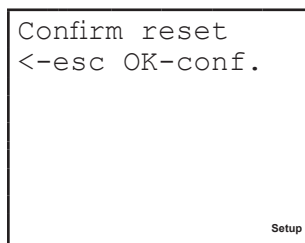

- 3) Press the **5** key to confirm the selection or the **1** key to cancel and return to the advanced menu level.

5.3.4 Configuration menu

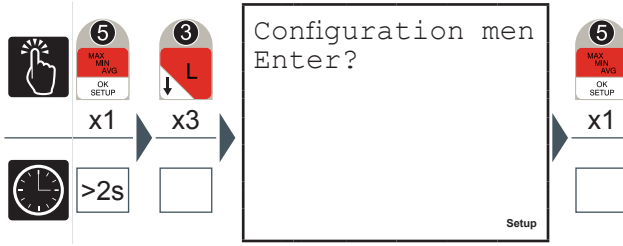

In this menu the settings of the parameters relative to the entry of the electric network device, the T2 hour counter, the generation functions, the back lighting and the conversion factors used to calculate the values in euro and CO2 can be made.

5.3.4.1 Type of entry

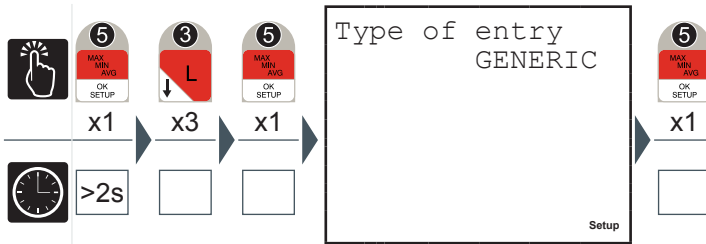

- 1) Press the 2 or the 3 key to navigate between the following options:
  - GENERIC
  - MONOPHASE
  - BALANCED 3-PHASE
  - 3-PHASE (default)
- 2) Press the 5 key to confirm.

Types of entry	Description / Effect	Note
MONOPHASE	The pages relative to the 3-phase size are not shown in the navigation menu	Use channel I1 to enter the current and channel L1-N for the voltage
3-PHASE	The self-diagnosis carries out controls on the correct insertion <sup>[1]</sup>	
BALANCED 3-PHASE	The value of the I1 current is assumed to be valid for the two remaining phases (allows you not to connect I2 and I3)	Use channel I1 to insert the current
GENERIC	The self-diagnosis does not carry out controls on the correct insertion	

<sup>[1]</sup> See paragraph [“5.3.10 Self-diagnosis menu”](#) for more information on the tests carried out.

5.3.4.2 Set CT ratio

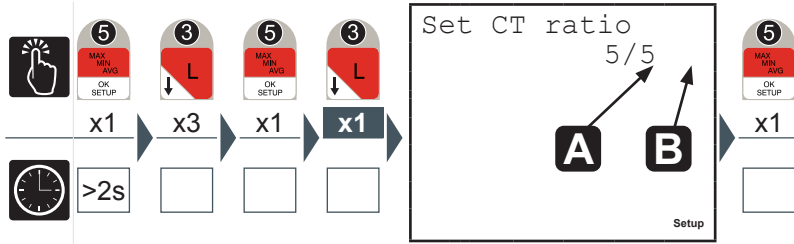

- 1) Insert a value between 1 A and 10000 A for the primary value in **A** (see paragraph "5.3.1.1 Data entry").
- 2) Move the cursor to the figure relative to the secondary current **B** and select 1 A or 5 A.
- 3) Press the **5** key to confirm.

If the CT is replaced varying the value of the transformation ratio, before proceeding we recommend:

- 1) Noting the value of the energy counts accumulated with the previous ratio.
- 2) Resetting the energy counts.
- 3) Insert a new value of the transformation ratio.

5.3.4.3 Set VT ratio

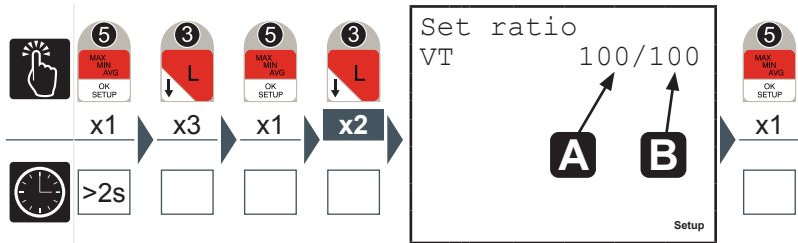

- 1) Insert a value between 60 V and 60000 V for the primary value in **A** (see paragraph [“5.3.1.1 Data entry”](#)).
- 2) Move the cursor to the figure relative to the voltage of the secondary **B** and insert a value between 60 V and 190 V (see paragraph [“5.3.1.1 Data entry”](#)).
- 3) Press the **5** key to confirm.



In case of direct insertion, up to 500 V phase-neutral, without voltage transformers set 100/100 (default) as value.

5.3.4.4 Average time

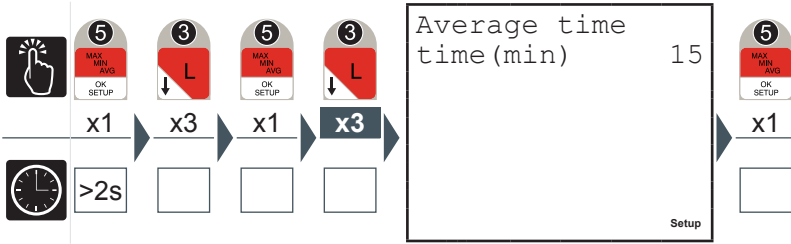

In this page the time intervals used by the device to carry out the calculation of the average values is set.

- 1) Insert a value between 1 and 60 minutes (see paragraph [“5.3.1.1 Data entry”](#)).
- 2) Press the **5** key to confirm.

5.3.4.5 Current threshold for T2 hour counter

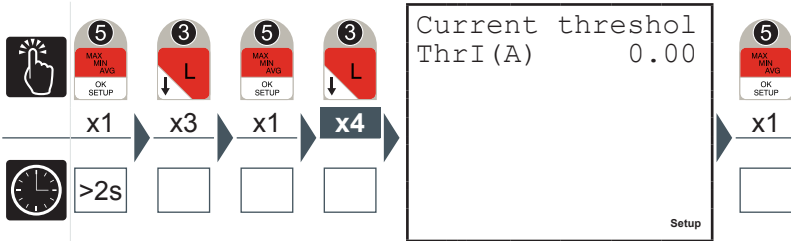

The current threshold for the T2 hour counter represents the minimum current value at which the counter begins the countdown.

- 1) Insert a value of between 0 and the nominal value of the current transformer used, KA\*5 (see paragraph [“5.3.1.1 Data entry”](#)).
- 2) Press the **5** key to confirm.



**KA and KV respectively represent the ammetric and voltmetric transformation ratio.**

5.3.4.6 *Hour counter count-down*

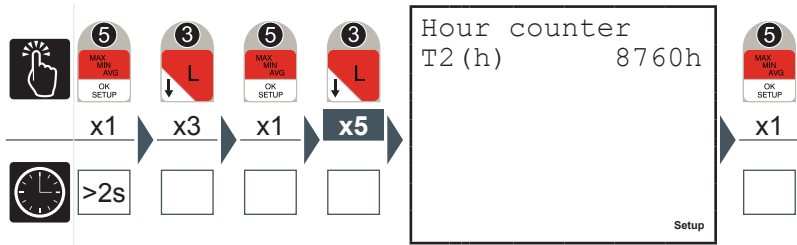

When the count down hour counter completes the countdown the **11** symbol will appear on the display.

- 1) Insert a value between 1 and 26280 hour (see paragraph [“5.3.1.1 Data entry”](#)).
- 2) Press the **5** key to confirm.

5.3.4.7 Generation

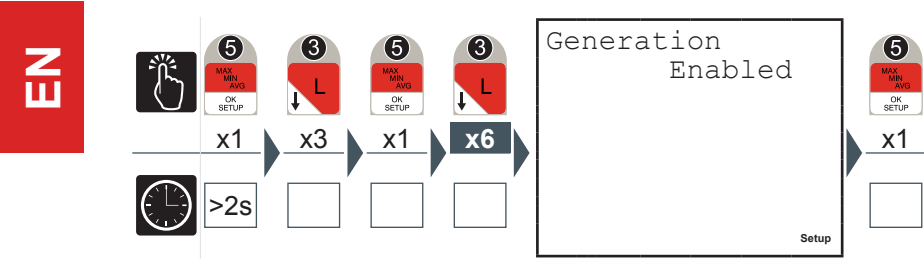

By activating the GENERATION option, the energy counts will be carried out on 4 quadrants separating energy and absorbed power, shown with the “+” sign, from that generated shown with the “-” sign.

**It is important that the insertion of the CT is carried out correctly adhering to the absorption direction of the current.**

- 1) Press the **2** or the **3** key to enable or disable the acquisition mode of the data in the 4 quadrants.
- 2) Press the **5** key to confirm.

If the Generation option is not active the instrument will carry out the automatic inversion of the current direction meaning that the powers active will always be positive and the energy count will occur on two quadrants. With each switching on or as soon as the current is different from 0, the analyser will automatically and in an independent manner for each phase, read the displacement of the current in respect to the corresponding phase voltage for some periods. If it finds that the current is out of phase it inverts the direction of the current concerned.



5.3.4.8 Euro/energy factor

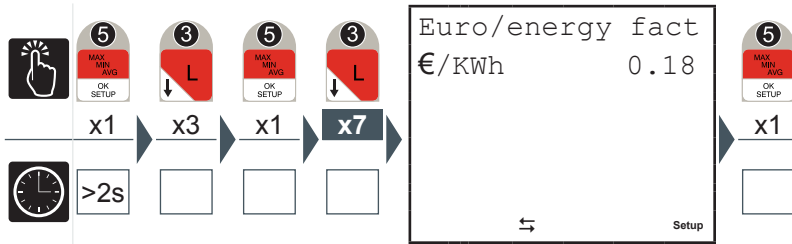

The active 3-phase energy, both absorbed and generated, is multiplied by the conversion factor so that the equivalent can be displayed in euro.

- 1) Insert a value between 0.01 and 9.99 (see paragraph [“5.3.1.1 Data entry”](#)).
- 2) Press the **5** key to confirm.

5.3.4.9 CO2/energy factor

The active 3-phase energy, both absorbed and generated, is multiplied by the

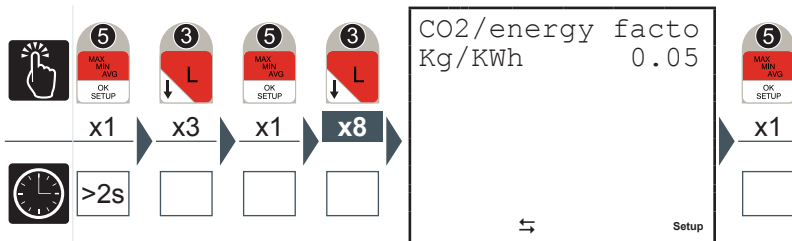

conversion factor so that the equivalent can be displayed in Kg CO2.

- 1) Insert a value between 0.01 and 9.99 (see paragraph [“5.3.1.1 Data entry”](#)).
- 2) Press the **5** key to confirm.

5.3.4.10 Back lighting

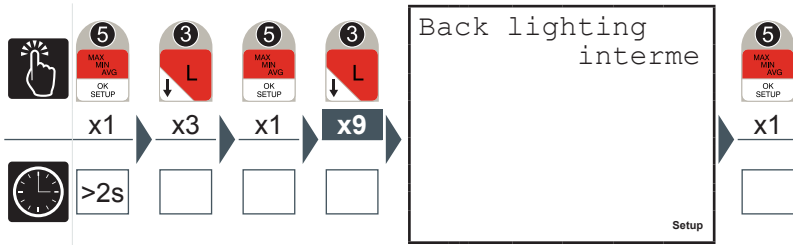

- 1) Press the **2** or the **3** key to navigate between the following options:
  - off
  - intermediate
  - maximum
- 2) Press the **5** key to confirm.

5.3.4.11 Energy saving

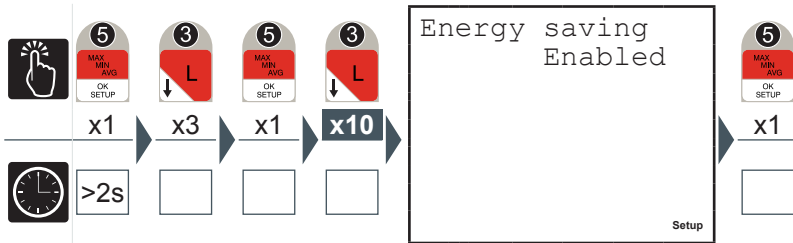

The energy saving foresees the automatic switching off of the back lighting (if not set at “off”) if the control keys **6** remain inactive for approx. 3 minutes.

The back lighting can be reactivated by pressing any of the **6** control keys.

- 1) Press the **2** key or the **3** key to enable or to disable the ‘Energy saving’ mode.
- 2) Press the **5** key to confirm.

### 5.3.5 Digital output menu

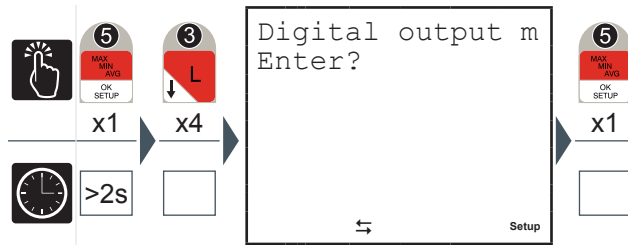

#### 5.3.5.1 Digital output mode

In this menu the parameters associated with the pulses or the alarms of the digital output available on all models, OUT1 and OUT2 can be set. Select “pulses” to use OUT1 and OUT2 as pulse output channels associated respectively with the 3-phase active energy and the 3-phase reactive energy. Select “Alarms” to use OUT1 and OUT2 as alarm output channels.

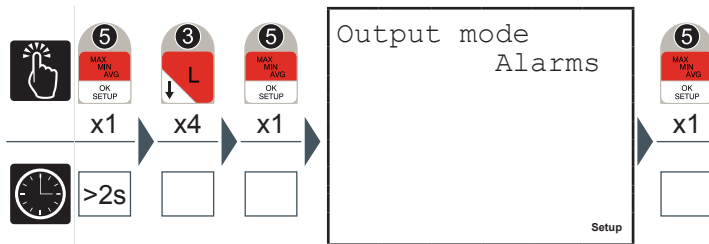

- 1) Press the **2** key or the **3** key to select one of the two options available ('Alarms' or 'Pulses').
- 2) Press the **5** key to confirm.

5.3.5.2 Energy value for pulse

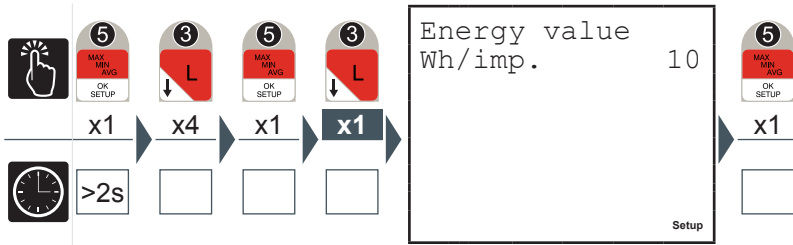

- 1) Press the **2** key or the **3** key to select one of the following values expressed in Wh/imp for OUT1 and VARh/imp for OUT2:
  - 10
  - 100
  - 1000
  - 10000
- 2) Press the **5** key to confirm.

5.3.5.3 Alarm1 or alarm2(\*) parameter

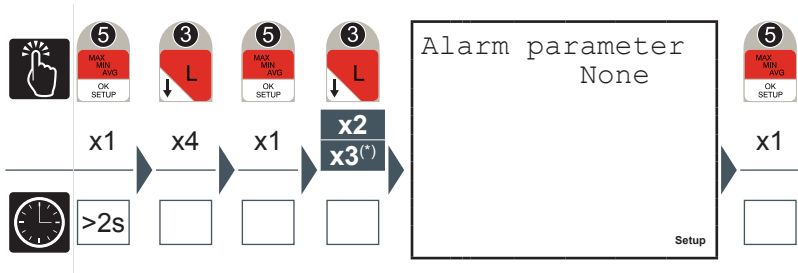

- 1) Press the **2** key or the **3** key to navigate between the parameters given in paragraph [“5.3.7.6 Output associated parameter table”](#).
- 2) Press the **5** key to confirm.

5.3.5.4 Alarm 1 or 2 threshold

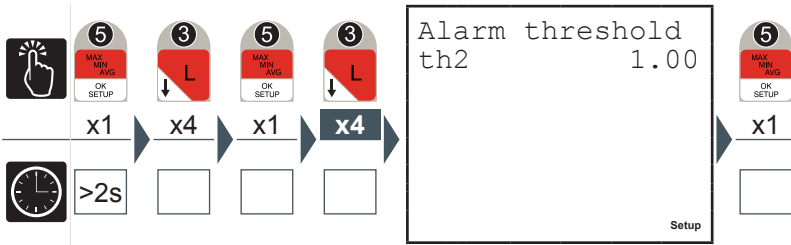

- 1) Insert the values required (see paragraph [“5.3.1.1 Data entry”](#)), checking the parameters and the setting intervals (see paragraph [“5.3.7.6 Output associated parameter table”](#)).
- 2) Press the **5** key to confirm.

5.3.5.5 Alarm 1 or 2 activation

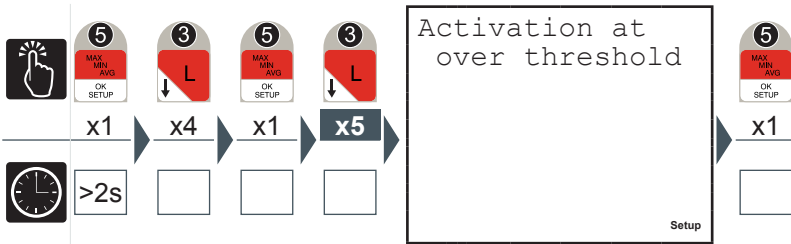

- 1) Press the **2** key or the **3** key to select one of the two options available ('over threshold' or 'below threshold').
- 2) Press the **5** key to confirm.

5.3.5.6 Alarms 1 or 2 activation delay

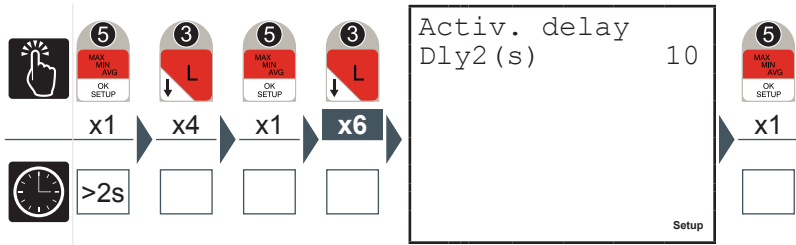

- 1) Insert a value between 1 and 900 seconds (see paragraph [“5.3.1.1 Data entry”](#)).
- 2) Press the **5** key to confirm.

In alarm situations the **10** symbol will flash on the display.  
Check which alarm is activated on the screen relative to the alarms status.

5.3.5.7 Alarm 1 or 2 hysteresis

- 1) Insert a value between 0 and 40% (see paragraph [“5.3.1.1 Data entry”](#)).

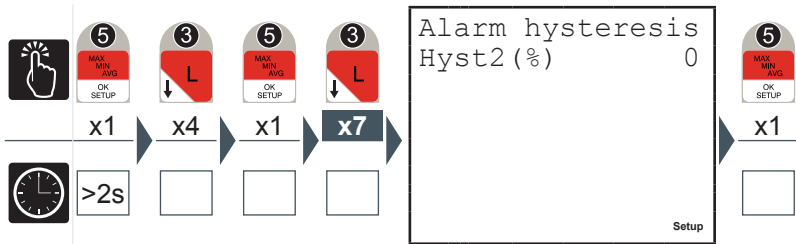

- 2) Press the **5** key to confirm.

5.3.6 Alarm output menu

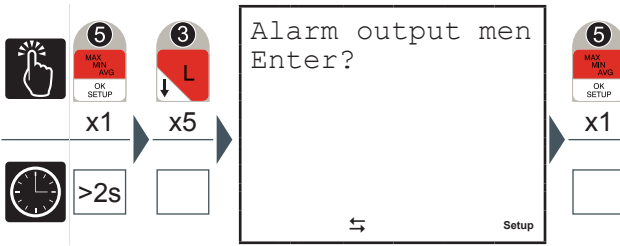

5.3.6.1 Alarm 3 or 4 parameter (\*)

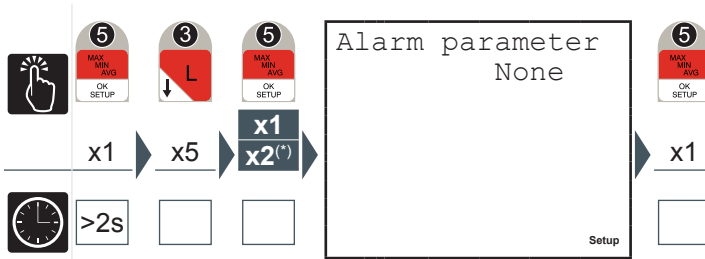

- 1) Press the **2** key or the **3** key to navigate between the parameters given in paragraph "5.3.7.6 Output associated parameter table".
- 2) Press the **5** key to confirm.



5.3.6.2 Alarm 3 or 4 threshold

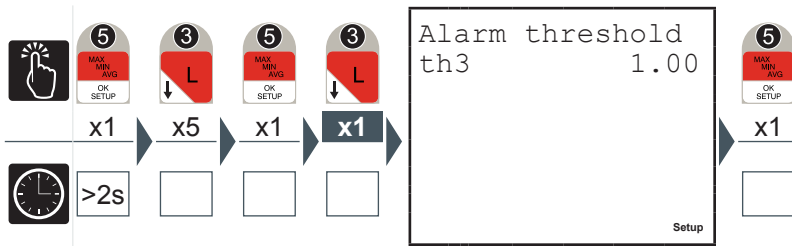

Insert the values required (see paragraph [“5.3.1.1 Data entry”](#)), checking the parameters and the setting intervals (see paragraph [“5.3.7.6 Output associated parameter table”](#)).

- 1) Press the **5** key to confirm.

5.3.6.3 Alarm 3 or 4 activation

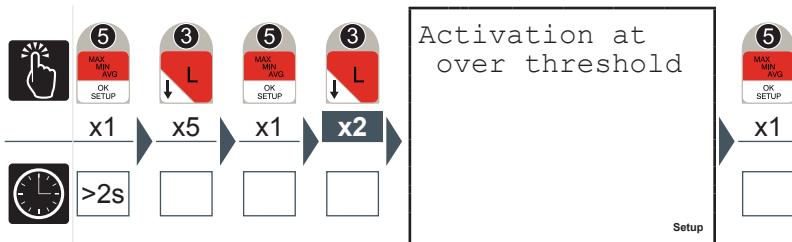

- 1) Press the **2** key or the **3** key to select one of the two options available ('over threshold' or 'below threshold').
- 2) Press the **5** key to confirm.

5.3.6.4 Alarms 3 or 4 activation delay

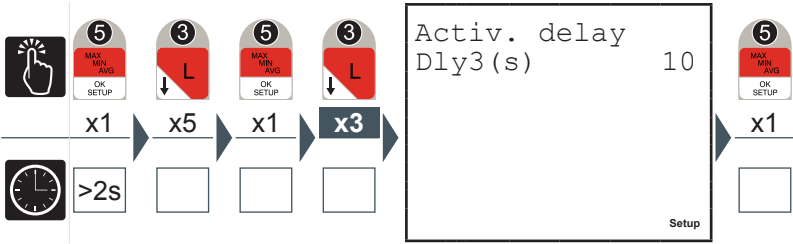

- 1) Insert a value between 1 and 900 seconds (see paragraph [“5.3.1.1 Data entry”](#)).
- 2) Press the **5** key to confirm.

In alarm situations the **10** symbol will flash on the display.  
Check which alarm is activated on the screen relative to the alarms status.

5.3.6.5 Alarm 3 or 4 hysteresis

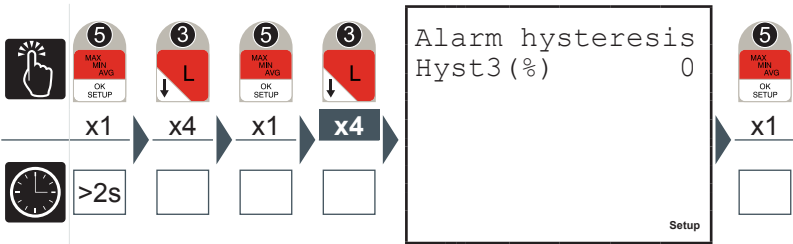

- 1) Insert a value between 0 and 40% (see paragraph [“5.3.1.1 Data entry”](#)).
- 2) Press the **5** key to confirm.

### 5.3.7 I/O card menu

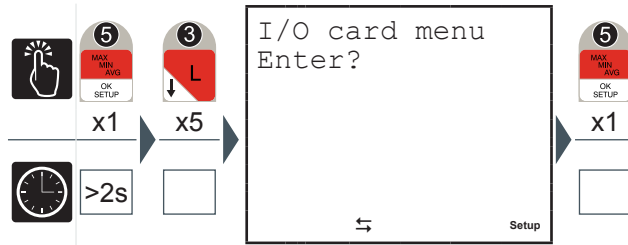

From the I/O card menu it is possible to set the parameters associated with the analog outputs 4-20mA (“AN-O1” and “AN-O2”) and the pulse reading inputs (“IN1”, “IN2” and “SYNCH”).

#### 5.3.7.1 Outputs span

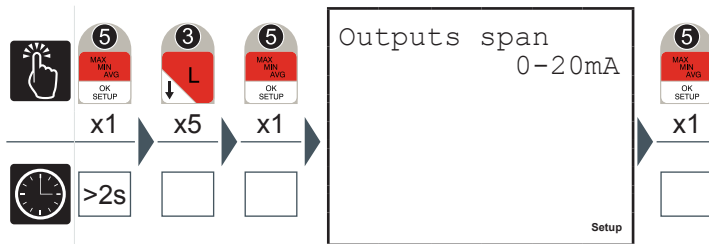

Selecting “0-20mA”, the output current will assume the values from 0 to 20mA proportional to the parameter associated therewith; when selecting “4-20mA” the values assumed by the output currents will be between 4 and 20 mA. Values lower than 4mA indicate a failure along the current loop.

5.3.7.2 *Output 1 parameter*

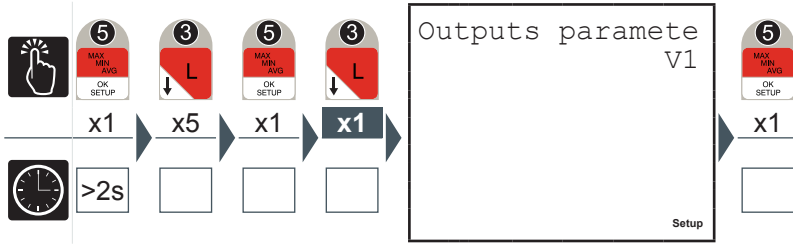

- 1) Press the **2** key or the **3** key to navigate between the parameter given in paragraph [“5.3.7.6 Output associated parameter table”](#).
- 2) Press the **5** key to confirm.

5.3.7.3 *Output 2 parameter*

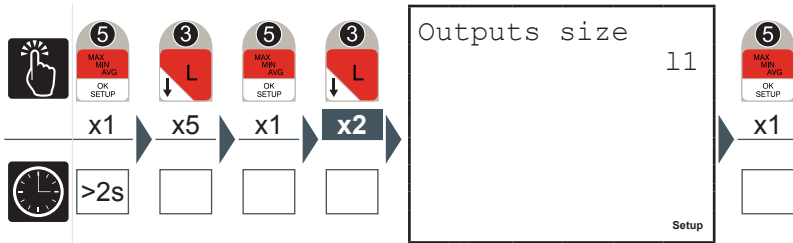

- 1) Press the **2** key or the **3** key to navigate between the parameter given in paragraph [“5.3.7.6 Output associated parameter table”](#).
- 2) Press the **5** key to confirm.

### 5.3.7.4 Input pulses factors

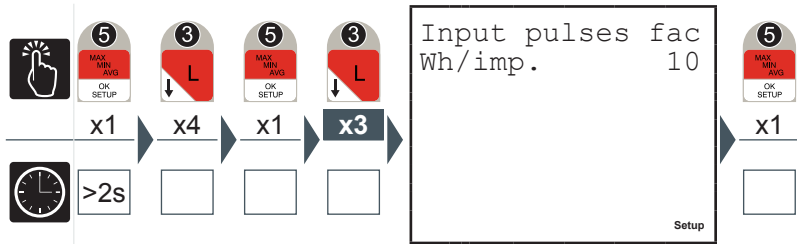

- 1) Insert the value required between 1 and 10000 Wh/pulses (see paragraph “5.3.1.1 Data entry”); in case of interface with analysers DUCA47 and SMART+ the same value must be set as in the setup of these instruments.
- 2) Press the **5** key to confirm.

### 5.3.7.5 External synchronism

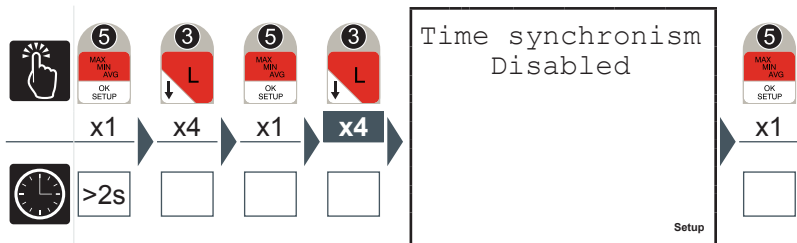

For the DUCA-LCD96 485-IO model the enabling of this parameter, in correspondence with the arrival of an external synchronism pulse, synchronises the calculation of all of the average values; any synchronism commands from protocol will not be accepted.

- 1) Press the **2** key or the **3** key to enable or disable the external synchronism of the average time.
- 2) Press the **5** key to confirm.

5.3.7.6 *Output associated parameter table*

The following table shows the parameters associated to alarm output and/or analog output in current.

Parameter	Measurement unit	Max. limit
Frequency	Hz	500
V12 concatenated voltage	V	KV * 866
V23 concatenated voltage	V	KV * 866
V31 concatenated voltage	V	KV * 866
L1 voltage	V	KV * 500
L2 voltage	V	KV * 500
L3 voltage	V	KV * 500
Equivalent 3-phase voltage	V	KV * 866
L1 current	A	KA * 5
L2 current	A	KA * 5
L3 current	A	KA * 5
3-phase current	A	KA * 5
L1 active power	W	KA * KV * 2500
L2 active power	W	KA * KV * 2500
L3 active power	W	KA * KV * 2500
3-phase active power	W	KA * KV * 7500
L1 reactive power	VAr	KA * KV * 2500
L2 reactive power	VAr	KA * KV * 2500
L3 reactive power	VAr	KA * KV * 2500
3-phase reactive power	VAr	KA * KV * 7500
L1 apparent power	VA	KA * KV * 2500
L2 apparent power	VA	KA * KV * 2500
L3 apparent power	VA	KA * KV * 2500
3-phase apparent power	VA	KA * KV * 7500
PF1		1.00
PF2		1.00
PF3		1.00
3-phase PF		1.00
T2 <sup>(1)</sup>	h	Activated when 0 is reached

<sup>(1)</sup>Parameter not associated to analog output in current.



**KA and KV respectively represent the ammetric and voltmetric transformation ratio.**

### 5.3.8 Communication menu

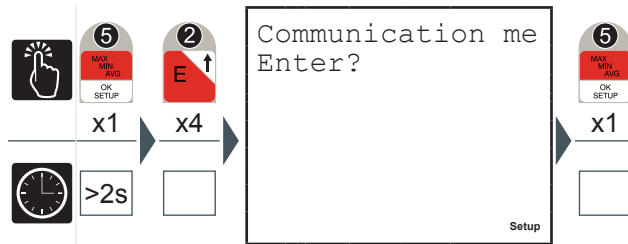

When the communication is active or the instrument is interrogated by a monitoring system and responds, the flashing communication active **8** symbol appears.

#### 5.3.8.1 PROFIBUS address (only DUCA-LCD96-PROFI)

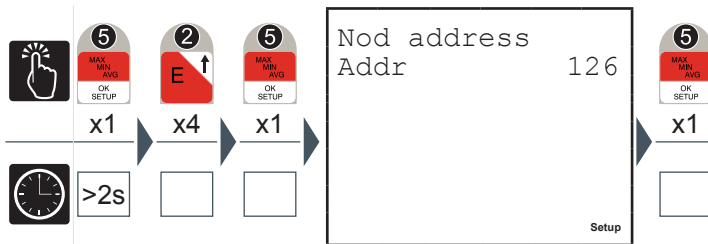

- 1) Enter the PROFIBUS node between 1 and 126 (see paragraph [“5.3.1.1 Data entry”](#)) to be associated with the instrument.
- 2) Press the **5** key to confirm.



This is the only page available in this menu for the DUCA-LCD96-PROFI model.

5.3.8.2 Serial protocol

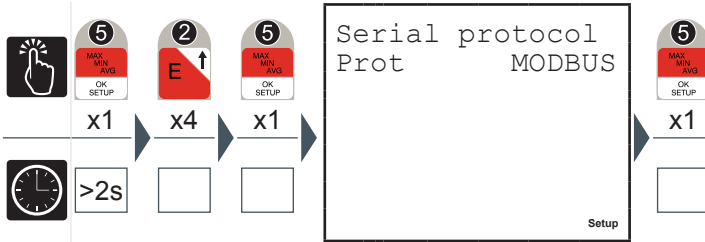

- 1) Press the **2** key or the **3** key to select one of the two options available ('MODBUS' or 'ASCII').
- 2) Press the **5** key to confirm.

5.3.8.3 Address

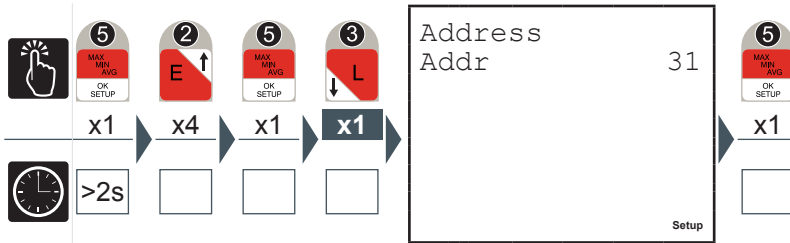

- 1) Insert a value between 1 and 247(for Modbus protocol) or between 1 and 98 (for ASCII protocol) (see paragraph [“5.3.1.1 Data entry”](#)).
- 2) Press the **5** key to confirm.



5.3.8.4 *Baud rate*

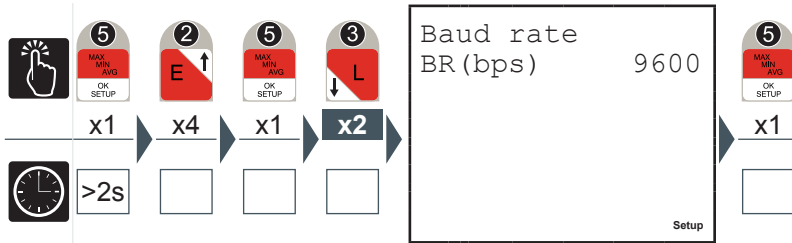

- 1) Press the **2** key or the **3** key to select one of the following values available:
  - 4800
  - 9600 (default)
  - 19200
- 2) Press the **5** key to confirm.

5.3.8.5 *Parity type*

- 1) Press the **2** key or the **3** key to select one of the following values available:
  - None (default)

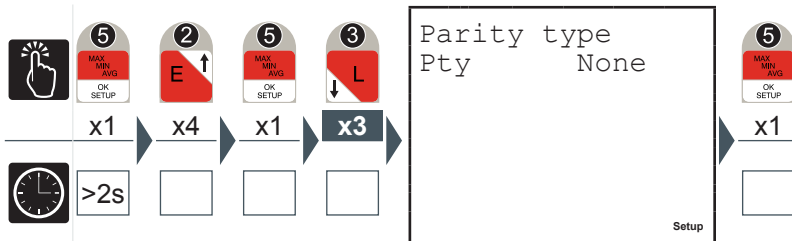

- EVEN
  - ODD
- 2) Press the **5** key to confirm.

5.3.8.6 *Number of stop bits*

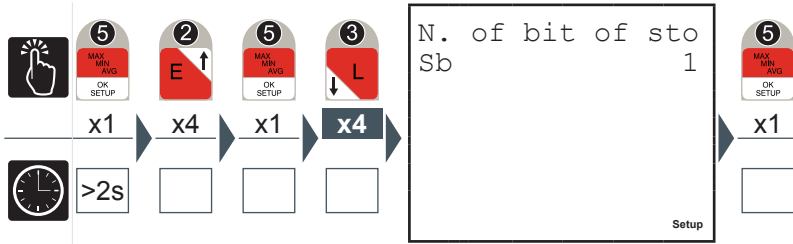

- 1) Press the **2** key or the **3** key to select one of the two options available ('1' or '2').
- 2) Press the **5** key to confirm.

5.3.8.7 *DHCP (only DUCA-LCD96 ETH)*

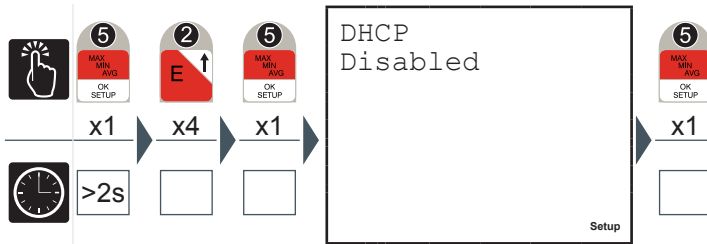

- 1) Press the **2** key or the **3** key to enable or disable the DHCP.
- 2) Press the **5** key to confirm.

### 5.3.8.8 IP Address (only DUCA-LCD96 ETH)

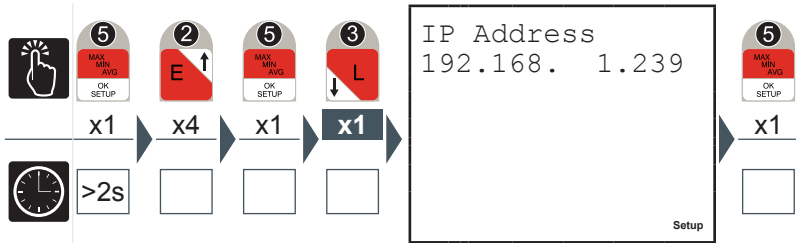

IP Address is modifiable only with DHCP = Disabled.

- 1) Enter the IP Address field each between 0 and 255 (see paragraph [“5.3.1.1 Data entry”](#)) to be associated with the instrument.
- 2) Press the **5** key to confirm.

### 5.3.8.9 Host name (only DUCA-LCD96 ETH)

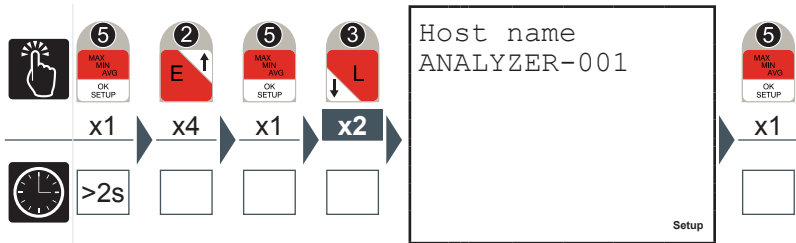

- 1) Enter the numerical field of the host name between 0 and 99 (see paragraph [“5.3.1.1 Data entry”](#)) to be associated with the instrument.
- 2) Press the **5** key to confirm.

**5.3.9** *Language menu*

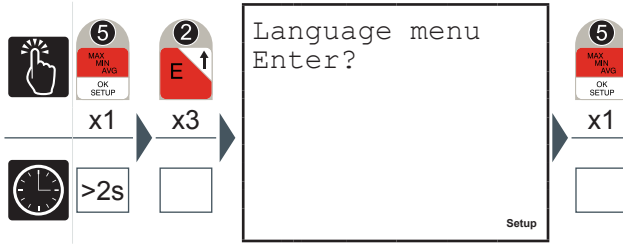

In this menu it is possible to specify the display language of the page.

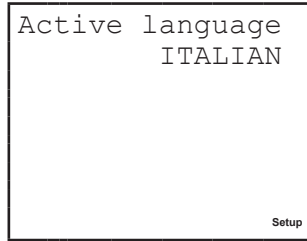

- 1) Press the **5** key to modify the language.
- 2) Press the **2** key or the **3** key to select the language required amongst those available.
- 3) Press the **5** key to confirm.



**Other languages, besides from Italian and English, are available from the firmware V2.0 version onwards**

### 5.3.10 Self-diagnosis menu

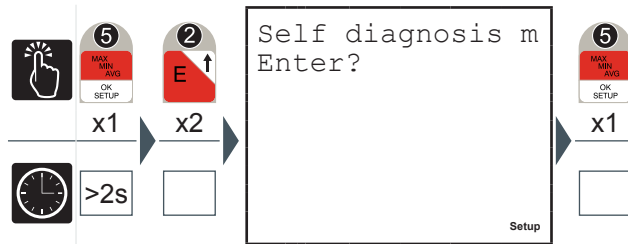

In this menu the device self-diagnosis procedure can be started up. The instrument is able to carry out a diagnosis on the correctness of the connections made by the user between the device and the network and various parameters, with indications of the code referred to the type of error.

Press the **5** key to carry out the self-diagnosis.

The tests carried out are:

- Internal data memory consistency and integrity control
- Voltage sequence verification
- Verification of the coherence between the insertions carried out and the configurations set
- Current sequence verification
- Uniformity verification of the powers in GENERATION mode (see [“5.3.4.7 Generation”](#))



**The self-diagnosis procedure is carried out a few seconds after the device is switched on and displays the results of the test on the screen for a few seconds before returning to the default page.**

If the self-diagnosis procedure detects non-conformities in the behaviour of the analyser, the **7** warning/error symbol will appear on the screen.

Consult the list of error codes (paragraph [“6.1.1 Error codes”](#)) to trace the cause of the problem.



**5.3.11 Info menu**

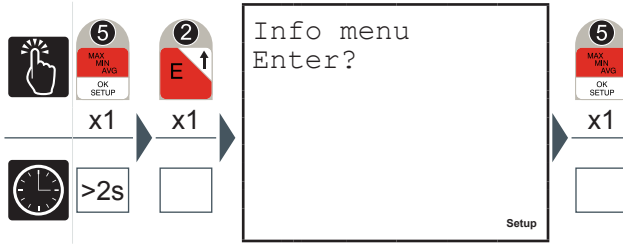

In this menu the identifying data of the device can be displayed, such as:

- Type of configuration
- Series number
- Firmware version

Press the **2** key or the **3** key to navigate between the pages and display the information required.

**5.3.12 SETUP mode exit**

To quickly exit from the SETUP mode keep the **5** key pressed for more than seconds.

**EN**

### 5.3.13 Setup parameters table and factory settings

Parameter	Settable values	Default
Average time (min)	[1+60]	15
CT ratio	[1+10000A] / (1A or 5A)	5/5
VT ratio	[1+60000V] / [60+190V]	direct insertion (100/100)
Output pulses factors (Wh/imp)	10, 100, 1000, 10000	10
Alarm parameter 1	See table " <a href="#">5.3.7.6 Output associated parameter table</a> "	None
Alarm parameter 2		
Alarm parameter 3		
Alarm parameter 4		
Alarm threshold 1	See table " <a href="#">5.3.7.6 Output associated parameter table</a> "	Max. limit = high full scale value of the parameter associated with the alarm
Alarm threshold 2		
Alarm threshold 3		
Alarm threshold 4		
Alarm 1 activation mode	Above threshold or below threshold	Above threshold
Alarm 2 activation mode		
Alarm 3 activation mode		
Alarm 4 activation mode		
Alarm 1 activation delay (s)	[1+900]	10
Alarm 2 activation delay (s)		
Alarm 3 activation delay (s)		
Alarm 4 activation delay (s)		
Alarm 1 activation hysteresis (% of the threshold)	[0+40]	0
Alarm 2 activation hysteresis (% of the threshold)		
Alarm 3 activation hysteresis (% of the threshold)		
Alarm 4 activation hysteresis (% of the threshold)		
RS-485 communication protocol	ASCII or MODBUS	MODBUS
Analyser address	MODBUS [1-247] ASCII [1-98] PROFIBUS [1-126]	MODBUS 31 ASCII 31 PROFIBUS 126
Baud rate	4.8Kbps, 9.6 Kbps, 19.2 Kbps	9.6 Kbps
DHCP	ENABLED / DISABLED	DISABLED
IP Address	xxx.xxx.xxx.xxx	192.168.1.239
Host name	ANALYZER-xxx	ANALYZER-001



Parameter	Settable values	Default
Analog current output span (mA)	0-20 or 4-20	0-20
Analog 1 output parameter	See table <a href="#">“5.3.7.6 Output associated parameter table”</a>	None
Analog 2 output parameter		
Input pulses factors (Wh/imp)	[1+10000]	10
Hour counter T2 (h)	[1+26280]	8760 (= 1 year)
Energy saving (automatic switching off of display backlight)	ENABLED/DISABLED	ENABLED
Display back lighting level	OFF, INTERMEDIATE, MAXIMUM	MAXIMUM
Configurations	MONOPHASE, 3-PHASE, BALANCED 3-PHASE, GENERIC	3-PHASE
Generation mode	ENABLED/DISABLED	DISABLED
Energy cost factor (€/KWh)	[0+9.99]	0.18
Conversion factor in CO2 (KgCO2/KWh)	[0+9.99]	0.05
Password	4 digit alphanumericals	0000 = disabled
Language	ENGLISH, ITALIAN, FRENCH(*), SPANISH(*), GERMAN(*), PORTUGUESE(*)	ENGLISH
Threshold in current for T2 timer (A)	[0 - KA*5]	0A
Digital output mode	Pulses or alarms	Pulses
External synchronism for average values	Enabled or disabled	Disabled

(\*) Other languages, asides from Italian and English, are available from the firmware V2.0 version onwards.







**KA and KV respectively represent the ammetric and voltmetric transformation ratio.**



## 5.4 Data reading

In DATA READING mode, the control keys **6** allow the navigation between the various reading pages of the parameter measured by the device.

Each key has a series of pages grouped according to the logic reported in the following table:

Key	Type of reading
	Voltage, Currents and 3-phase powers, instant values, peak and average
	Energies
	Voltage, Currents and single phase powers
	THD, alarms, hour counters and and external pulse counters
	Access to peak, average and maximum demand values menus

Press the key corresponding to the data reading which you wish to carry out to display the start page.

Each subsequent pressing of the same key cause the scrolling (cyclic) of the pages available up to the return to the start page.



**When you move from one key to another the first page to be displayed is always the start page.**

The display duration of a page is a maximum of 3 minutes after which the device will return to the default page.

### 5.4.1 Default page setting

To reset the default page:

- 1) Display the page you wish to set as the default page;
- 2) Keep the **4** and **5** keys pressed down contemporaneously for more than 3 seconds.

5.4.2 Voltages, Currents and 3-phase powers

EN

<p><b>3-phase value</b></p> <p>3-phase value PF 3F CAP0.99</p> <p>VIP x1</p> <p>398 V 2.93 A 1.99kW</p>	<p><b>Phase-neutral voltages</b></p> <p>Phase-neutral vo Frq 50.0Hz</p> <p>VIP x2</p> <p>L1 230 V L2 231 V L3 228 V</p>
<p><b>Concatenated voltages</b></p> <p>Concatenated vol Frq 50Hz</p> <p>VIP x3</p> <p>L12 399 V L23 398 V L31 397 V</p>	<p><b>Currents</b></p> <p>Currents 3F 2.93A</p> <p>VIP x4</p> <p>L1 3.40 A L2 1.30 A L3 4.10 A</p>
<p><b>Active power</b></p> <p>Active power 3F 2.00KW</p> <p>VIP x5</p> <p>L1 774 W L2 300 W L3 925 W</p>	<p><b>Reactive power</b></p> <p>Reactive power 3F 240Var</p> <p>VIP x6</p> <p>L1 109 VAR L2 0 VAR L3 131 VAR</p>
<p><b>Apparent power</b></p> <p>Apparent power 3F 2.02KVA</p> <p>VIP x7</p> <p>L1 782 VA L2 300 VA L3 935 VA</p>	<p><b>Power factors</b></p> <p>Power factors 3F CAP 0.99</p> <p>VIP x8</p> <p>L1 + 0.99 L2 1.00 L3 + 0.99</p>

**5.4.3 Energies**

**Active energies**



Active energies  
3F 1.11MWh

L1	307.1kWh
L2	272.0kWh
L3	530.3kWh

**Reactive energies**



Reactive energie  
3F 90.52

L1	30.25kVAh
L2	22.51kVAh
L3	37.76kVAh

**Apparent energies**



Apparent energie  
3F 1.11MVAh

L1	308.1kVAh
L2	273.5kVAh
L3	531.2kVAh

**Active energies activated**



Active energy g  
3F - 226.39KWh

L1	-80.21kWh
L2	-72.30kWh
L3	-73.88kWh

**Reactive energies generated**



Reactive energie  
3F .30KVAh

L1	-50.2VAh
L2	-70.1VAh
L3	-10.0VAh

**Apparent energies generated**



Apparent energie  
3F - 227.81KVAh

L1	-80.90kVAh
L2	-72.85kVAh
L3	-74.06kVAh

**Partial energy balance**



Partial balances

10kWh
1kVAh
10kVAh

**Total energies balance**



Total balances  
and

883.0kWh
89.22kVAh
885.0kVAh





**Equivalent active euro energy**

Equivalent euro €	199.8
----------------------	-------

 x9

**Equivalent active CO2 energy**

Equivalent C02 KgC02	55.4
-------------------------	------

 x10

**Equivalent active euro energy generated**

Equivalent euro €	40.7
----------------------	------

 x11

↔







**Equivalent active CO2 energy generated**

Equivalent C02 KgC02	11.3
-------------------------	------

 x12

↔









**5.4.4 Voltage, Currents and single phase 3-phase Powers**

Phase 1 values		Phase 1 powers	
 <p>x1</p>	<div style="border: 1px solid black; padding: 5px;"> <p>Phase 1 values PF1            CAPO.99</p> <p>L1    230 V       3.40 A       774 W</p> </div>	 <p>x2</p>	<div style="border: 1px solid black; padding: 5px;"> <p>Phases powers Frq            50.0Hz</p> <p>L1    774 W       109 VAR       782 VA</p> </div>
Phase 2 values		Phase 2 powers	
 <p>x3</p>	<div style="border: 1px solid black; padding: 5px;"> <p>Phase 2 values PF2            1.00</p> <p>L2    231 V       1.30 A       300 W</p> </div>	 <p>x4</p>	<div style="border: 1px solid black; padding: 5px;"> <p>Phases powers Frq            50.0Hz</p> <p>L2    300 W       0 VAR       300 VA</p> </div>
Phase 3 values		Phase 3 powers	
 <p>x5</p>	<div style="border: 1px solid black; padding: 5px;"> <p>Phase 3 values PF3            CAPO.99</p> <p>L3    228 V       4.10 A       925 W</p> </div>	 <p>x6</p>	<div style="border: 1px solid black; padding: 5px;"> <p>Phases powers Frq            50.0Hz</p> <p>L3    925 W       131 VAR       935 VA</p> </div>



5.4.5 THDF, Alarms, Timer and input pulses

EN

<p><b>Total voltage harmonic distortion factor (%)</b></p>  <p>x1</p> <p>Distortion facto THDFV%</p> <p>L1 11 L2 00 L3 11</p>	<p><b>Total voltage harmonic distortion factor</b></p>  <p>x2</p> <p>Distortion facto THDFV</p> <p>L1 1.01 L2 1.00 L3 1.01</p>
<p><b>Total current harmonic distortion factor (%)</b></p>  <p>x3</p> <p>Distortion facto THDFI%</p> <p>L1 13 L2 22 L3 33</p>	<p><b>Total current harmonic distortion factor</b></p>  <p>x4</p> <p>Distortion facto THDFI</p> <p>L1 1.13 L2 0.98 L3 0.97</p>
<p><b>Alarms status</b></p>  <p>x5</p> <p>Alarms status 4 o f f</p> <p>3 on 2 off 1 off</p> <p>Alarm</p>	<p><b>Hour counter 1 free-running</b></p>  <p>x6</p> <p>Hour counter 1 f T1 192.42h</p>
<p><b>Hour counter 2 count-down</b></p>  <p>x7</p> <p>Hour counter 2 c T2 8640.17h</p>	<p><b>Pulses input 1</b></p>  <p>x8</p> <p>Pulses input 1 320.3KWh</p> <p>2.50kW</p>

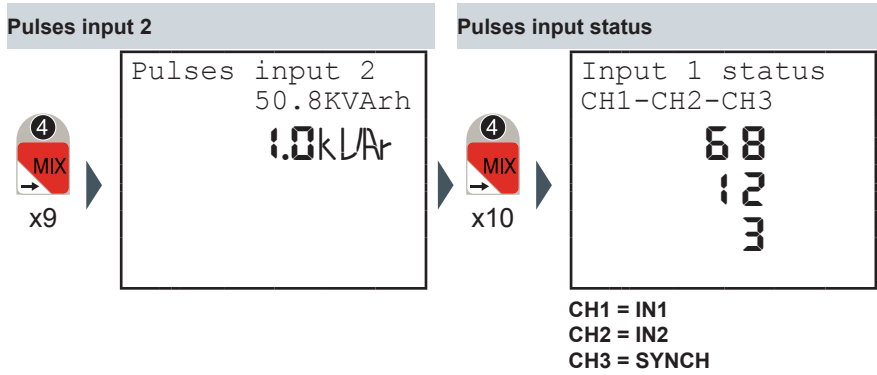

5.4.6 Maximums

EN

**Maximum 3-phase values**

Maximum values

400 V  
2.99 A  
2.10kW

5 MAX MIN AVG OK SETUP x1

1 VIP

**Phase-neutral voltages maximums**

Maximum voltages

L1 233 V  
L2 233 V  
L3 232 V

5 MAX MIN AVG OK SETUP x1

1 VIP x1

**Maximum concatenated voltages**

Maximum voltages

L12 403 V  
L23 402 V  
L31 402 V

5 MAX MIN AVG OK SETUP x1

1 VIP x2

**Maximum current**

Maximum current  
3F 3.20A

L1 3.80 A  
L2 2.00 A  
L3 4.80 A

5 MAX MIN AVG OK SETUP x1

1 VIP x3

**Maximum active power**

Maximum power  
3F 1.50KW

L1 880 W  
L2 460 W  
L3 1.10kW

5 MAX MIN AVG OK SETUP x1

1 VIP x4

**Maximum reactive power**

Maximum power  
3F 290VAr

L1 110 LAr  
L2 20 LAr  
L3 140 LAr

5 MAX MIN AVG OK SETUP x1

1 VIP x5

**Maximum apparent power**

Maximum power  
3F 2.40KVA







L1 885 LA  
L2 465 LA  
L3 1.13kLA

5 MAX MIN AVG OK SETUP x1

1 VIP x6



**5.4.7 Minimums**

<p><b>Minimum 3-phase values</b></p>  <div style="border: 1px solid black; padding: 5px; text-align: center;"> <p>Minimum values</p> <p>398 V</p> <p>0.80 A</p> <p>200 W</p> </div>	<p><b>Minimum phase-neutral voltages</b></p>  <div style="border: 1px solid black; padding: 5px;"> <p>Minimum voltages</p> <p>L1 398 V</p> <p>L2 399 V</p> <p>L3 396 V</p> </div>
<p><b>Minimum concatenated voltages</b></p>  <div style="border: 1px solid black; padding: 5px;"> <p>Minimum voltages</p> <p>L12 399 V</p> <p>L23 398 V</p> <p>L31 397 V</p> </div>	<p><b>Minimum currents</b></p>  <div style="border: 1px solid black; padding: 5px;"> <p>Minimum currents</p> <p>3F 0.80A</p> <p>L1 0.20 A</p> <p>L2 0.50 A</p> <p>L3 0.10 A</p> </div>
<p><b>Minimum active powers</b></p>  <div style="border: 1px solid black; padding: 5px;"> <p>Minimum powers</p> <p>3F 190W</p> <p>L1 46 W</p> <p>L2 115 W</p> <p>L3 23 W</p> </div>	<p><b>Minimum reactive powers</b></p>  <div style="border: 1px solid black; padding: 5px;"> <p>Minimum powers</p> <p>3F 4VAr</p> <p>L1 0 VAr</p> <p>L2 0 VAr</p> <p>L3 1 VAr</p> </div>
<p><b>Minimum apparent powers</b></p>  <div style="border: 1px solid black; padding: 5px;"> <p>Minimum powers</p> <p>3F 199VA</p> <p>L1 48 VA</p> <p>L2 119 VA</p> <p>L3 25 VA</p> </div>	



5.4.8 Averages

EN

**Average active powers**

Average power at 3F 1.92KW

L1	700 W
L2	315 W
L3	900 W

**Average reactive powers**

Average power re 3F 231VAr

L1	100 VAr
L2	1 VAr
L3	130 VAr

**Average apparent powers**

Average power ap 3F 2.02KVA

L1	780 VA
L2	298 VA
L3	937 VA

5.4.9 Maximum demand

**Maximum active power demand**

Max-Demand Poten 3F 1.97KW

L1	760 W
L2	370 W
L3	920 W

**Maximum apparent power demand**

Max-Demand Poten 3F 2.17KVA

L1	810 VA
L2	350 VA
L3	1.0 kVA

## 6 TROUBLESHOOTING

### 6.1 Problems, causes, solutions

The information contained in this chapter is not exhaustive but an attempt to provide specialised technicians with information to help them in trouble-shooting the most common problems.



The indications in the item "Suggested actions" in the table below **DO NOT AUTHORISE** interventions if they in any way compromise safety.

Problem	Possible cause	Suggested action
The instrument does not switch on	Incorrect or non-connected auxiliary power supply	Check the connection and the presence of the auxiliary voltage
The display is completely dark or clear	Back lighting is badly regulated	Regulate back lighting
The instrument does not communicate with the software	Communication cables	Check the correct connection of the device
	Communication protocol	Check that the communication protocol of the device coincides with that used in the software.
	Type of connection and communication parameters	Check the type of connection and the settings of the device serial port
The instrument communicates with the pc but the communication is interrupted	Non-shielded connection cables	Use shielded cables
	Lack of terminations	Insert the terminations

**6.1.1 Error codes**

**EN**

Code	Type	Description	Suggested action
1	Internal memory error	Internal memory damaged	Contact the manufacturer
2	Voltage Errors	V1 zero	Check voltage presence
3	Voltage Errors	V2 and/or V3 zero with config. = TRIPHASE or BALANCED 3-PHASE	Check voltage presence or set the correct configuration
4	Voltage Errors	Voltage not at 120° amongst themselves with config. = 3-PHASE or BALANCED 3-PHASE	Check voltage presence or set the correct configuration
5	Current Error	I1 = 0	Check connection layouts check the TA connections and load presence
6	Current Error	I2 and/or I3 zero with config. = 3-PHASE	Set configuration correctly
7	Warning	V2 and/or V3 not zero with config. = SINGLEPHASE	Check the connection layouts or correctly set the configuration
8	Voltage sequence error	Possible inversions of 2 phases	Check connection layouts
9	Warning	I2 and/or I3 not zero with config. = SINGLEPHASE or BALANCED 3-PHASE	Check the connection layouts or correctly set the configuration
10	Warning	Possible current order inversion error	Check connection layouts
11	Warning	Possible inversion of I1 and I2	Check connection layouts
12	Warning	Possible inversion of I1 and I3	Check connection layouts

Code	Type	Description	Suggested action
13	Warning	Possible inversion of currents I1 and I3	Check connection layouts
14	Warning	Possible inversion of the CT1 direction in generation mode	Check connection layouts
15	Warning	Possible inversion of the CT2 direction in generation mode	Check connection layouts
16	Warning	Possible inversion of the CT3 direction in generation mode	Check connection layouts

If the operating problems have not been solved or the information is not contained in this manual, please contact the Technical Assistance Service.

Collect as much information as possible relative to the installation and, in particular, the following data:

- 1) Model and serial number of the instrument (data is indicated on the shield applied on the container at the rear).
- 2) Purchase date of the materials.
- 3) Description of the problem.
- 4) System configuration: type of insertion, CT and TV ratio, connections with external communication devices, etc.



# Contact us



**DUCATI** energia

Via M. E. Lepido, 182  
40132 Bologna – Italy  
Ph.: +39 – 051 6411511  
Fax: +39 – 051 6411690

**[www.ducatienergia.com](http://www.ducatienergia.com)**

**E-mail (Sales): [info@ducatienergia.com](mailto:info@ducatienergia.com)**

**E-mail (Technical): [Supporto\\_Analizzatori@ducatienergia.com](mailto:Supporto_Analizzatori@ducatienergia.com)**

More info



DUCATI Energia S.p.A cannot be held liable for any damage or personal injury arising from incorrect or improper use of its equipments.

These documents are subject to changes without prior notice.

Document code: Version 1.1 – July 2014