

MECHANISMS AND TOOLS FOR TILT-AND-TURN

GALIPLUS 2



Made in Italy

fapim[®]

Life in evolution

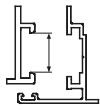

C.E.
10x14.5
12x15
13.6x16.8
14x18

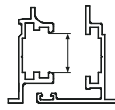







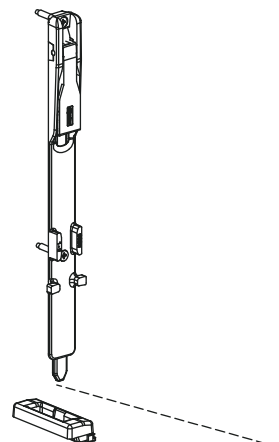
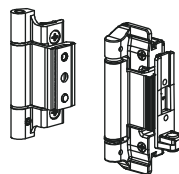
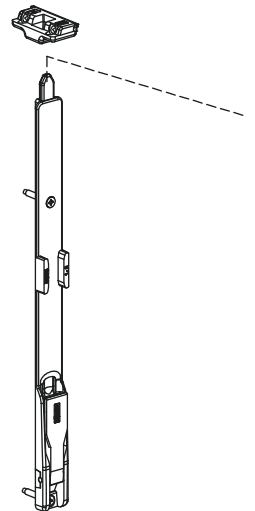
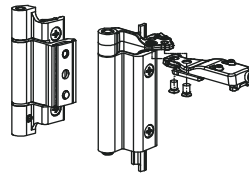
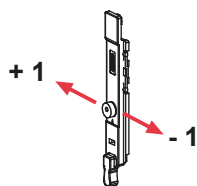
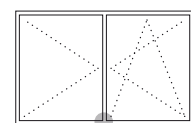
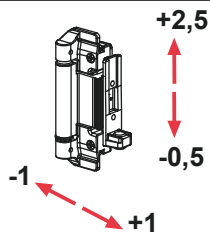
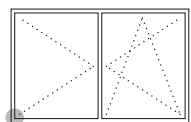
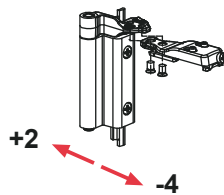
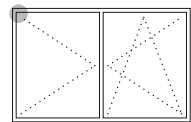
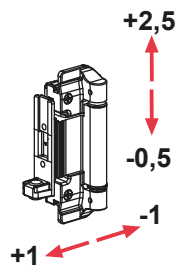
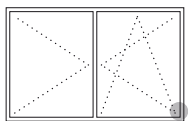
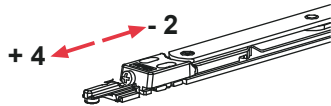
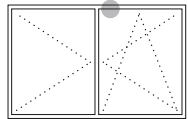

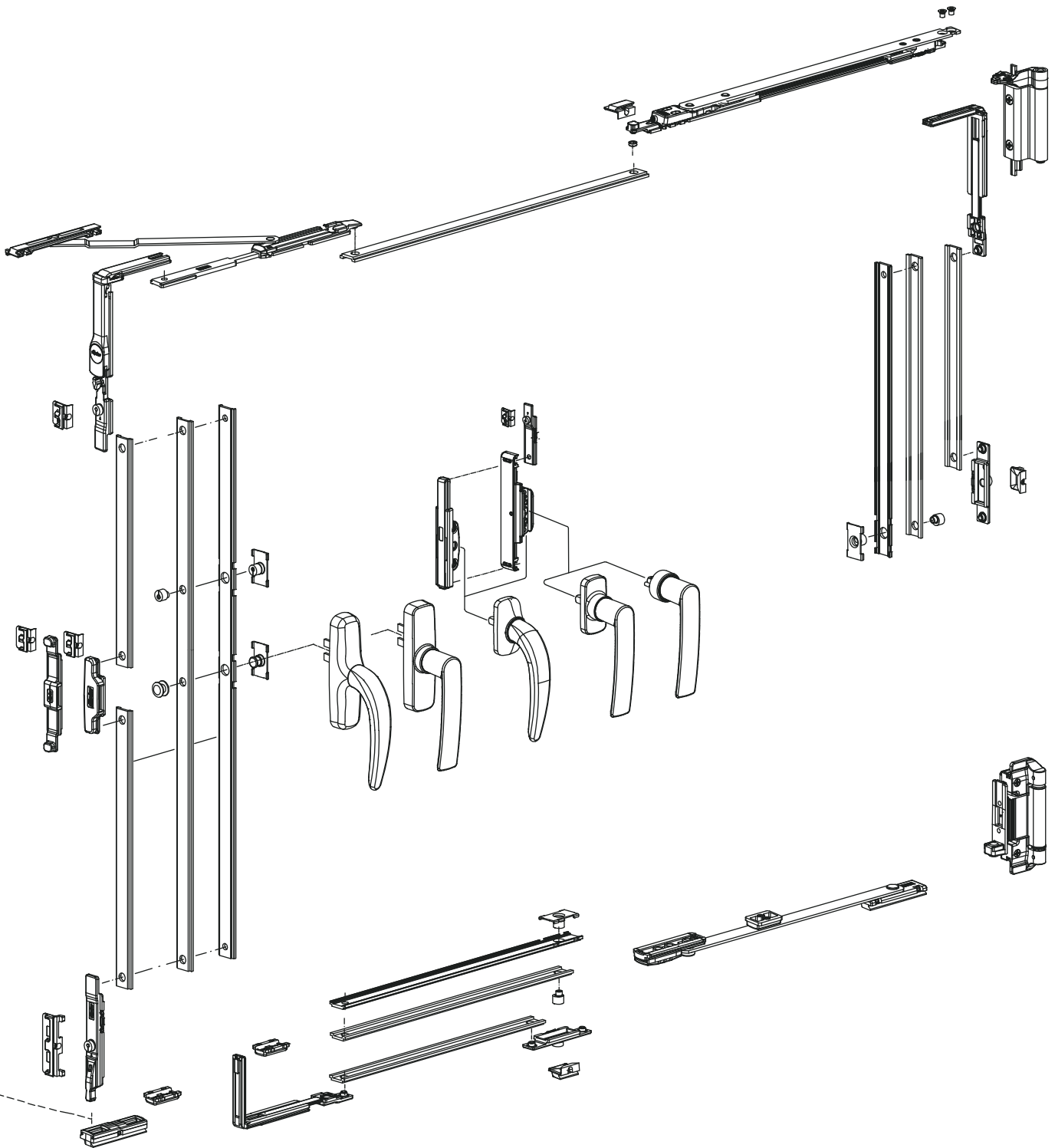
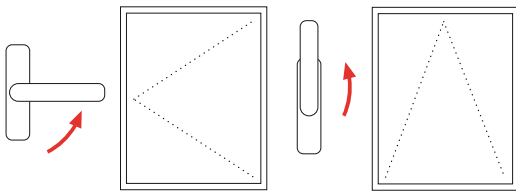



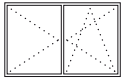

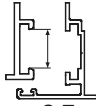
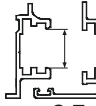

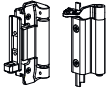

C.E.
13.6x16.8
14x18

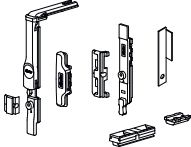
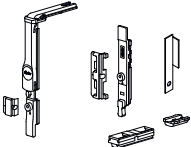

Kg 130



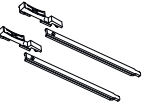

GALIPLUS 2					 C.E.	 C.E.	 Kg	
	1405	●	●				130	10
	1405i	●	●					50
	1406		●					50
	1449	●	●	364 ÷ 700				10
	1449A	●	●	402 ÷ 750				10
	1449Ai	●	●					50
	1450A	●	●	562 ÷ 1200				10
	1450Ai	●	●					50
	1451	●	●	816 ÷ 1700				10
	1455	●	●	1200 ÷ 1700				10
	1459	●	●	364 ÷ 800	10x14.5 12x15 13.6x16.8 14x18	10x14.5 12x15 13.6x16.8 14x18		10
1459B	●	●	800 ÷ 1700					
	1480	●	●					10
	1481i	●	●					50
	1482Ai		●			13.6x16.8 14x18		50
	1495Ai	●	●		10x14.5 12x15 13.6x16.8 14x18			50
	1497A	●	●					
	1501		●			10x14.5 12x15 13.6x16.8 14x18		10
	1503		●			13.6x16.8 14x18		10
	1505		●			14x18 15x20		10
	1506					13.6x16.8		
	1508		●			13.6x16.8 14x18 15x20		10
	1509A					13.6x16.8		20
	1509B		●			14x18		
	1509C					15x20		

					 C.E.	 C.E.	 Kg		
	1558	●	●		10x14.5 12x15 13.6x16.8 14x18	10x14.5 12x15 13.6x16.8 14x18		50	
	1559	●	●						50
	1559A	●	●						50
	1563i	●	●						100
	1565i6	●	●						100
	1566A	●	●						50
	1581A	●	●						50
	1585	●	●						50
	1593i	●	●						100
	1596B	●	●						50
	1596C	●	●						50
	1596i6	●	●						100
	1597i	●	●						100
	1597A	●	●						50
	1618	●							50
	1618B	●							50
	1620		●						50
	1622		●						50
	1626		●					15x20	10
	1636	●	●						50
	1636A	●	●				50		
	1636C	●	●			10x14.5 12x15 13.6x16.8 14x18	50		
	1640	●	●				10		
	4134		●				100		
	9826		●				50		



FP-13

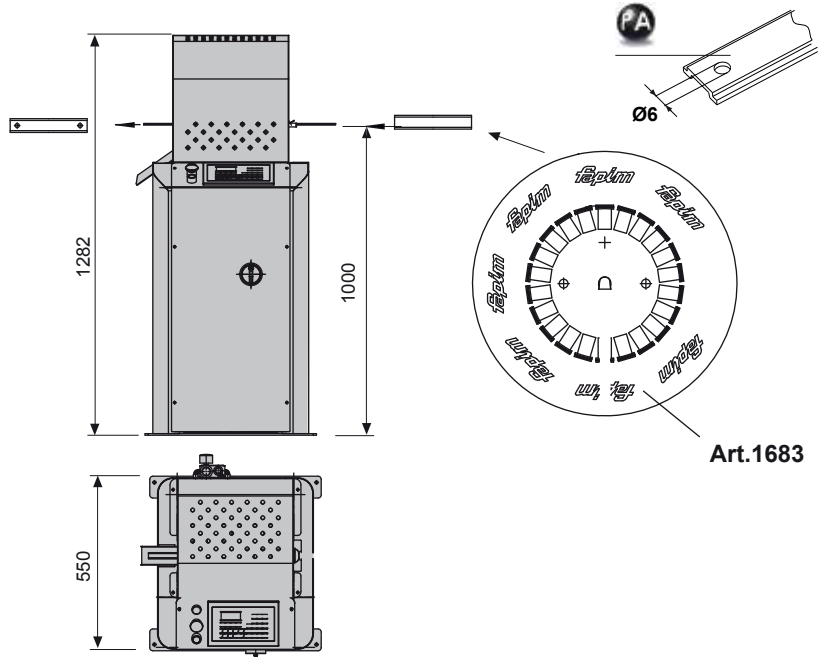

1684		1
------	--	---



FP-16

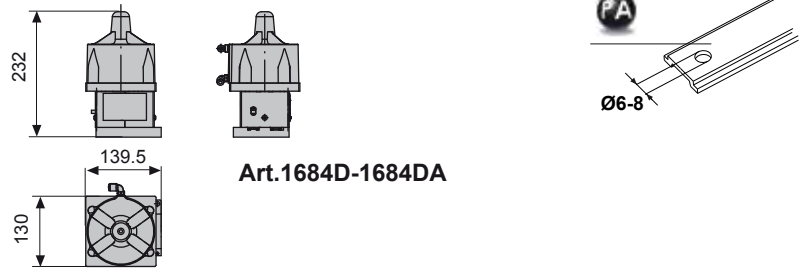

	Ø		
1684D	6 - 8		1
1684DA	6		1
1684D1			1
1684D3			1

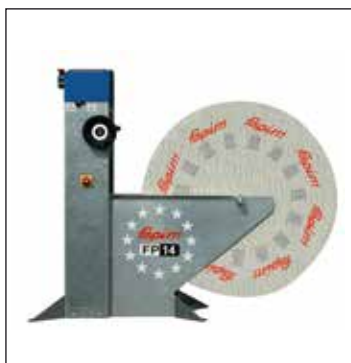
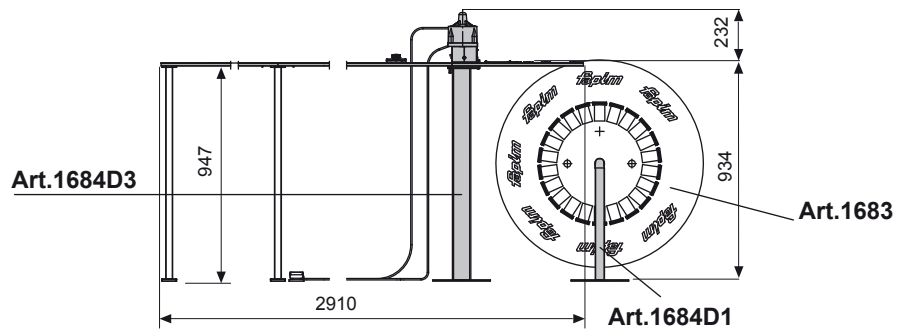

FP-14

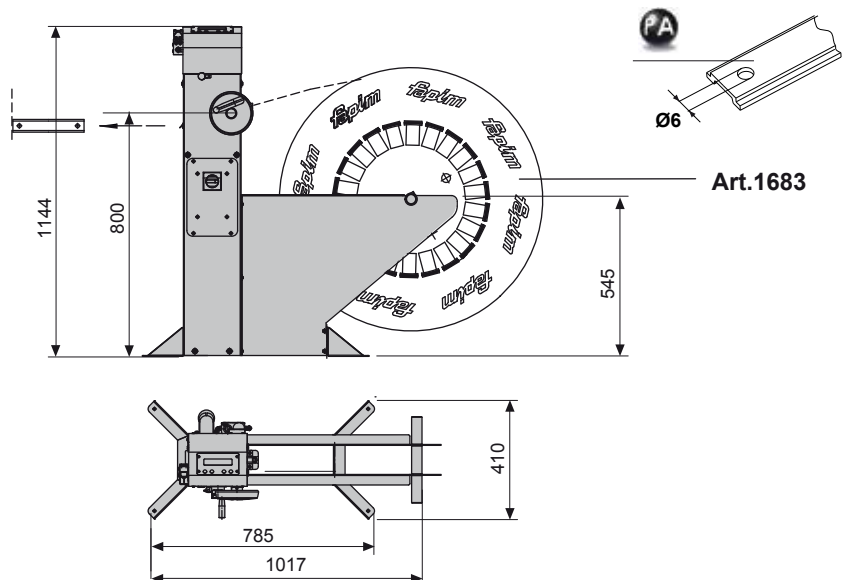

1684C		1
-------	--	---

AL PA

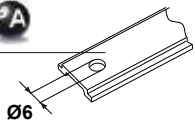

FP-12

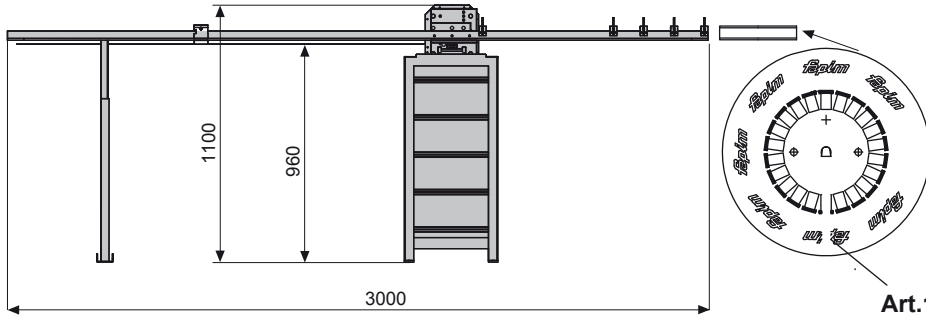

Art.1683



1685		1
1686		1

**FP-12
FP-13
FP-16**

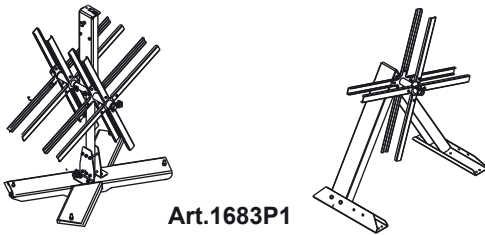

Art.1683P2

Art.1683P1

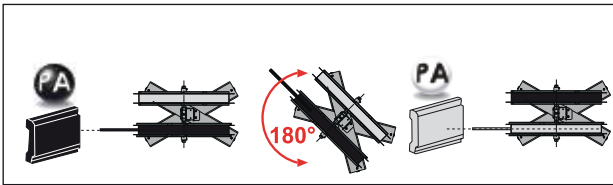

**FP-12
FP-13
FP-14
FP-16**

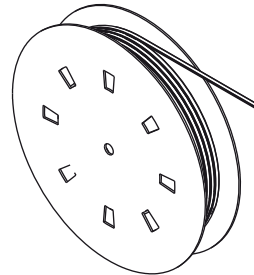

Art.1683



1683		1
1684P1		1
1684P2		1

**FP-13
FP-14
FP-16**

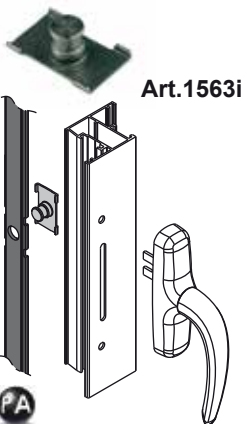

Art.1563i

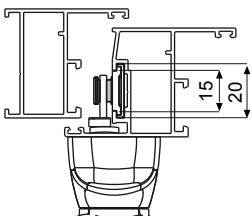

FP-12

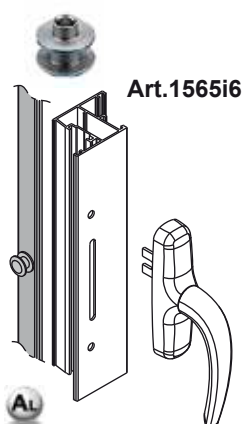

Art.1565i6

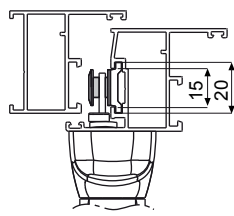

**FP-13
FP-14
FP-16**

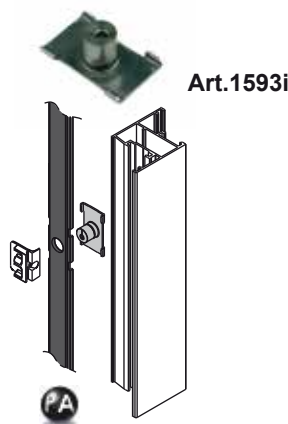

Art.1593i

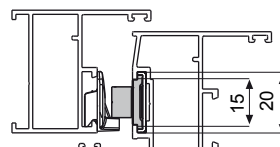

FP-12

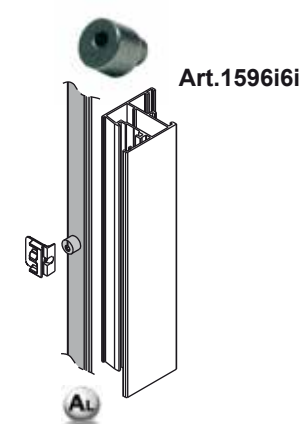

Art.1596i6i

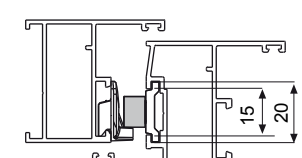



fapim[®]

Fapim S.p.A.
Via delle Cerbaie, 114
55011 Altopascio (LU) Italy
T +39 0583 2601 F +39 0583 25291
www.fapim.it info@fapim.it
Cod.Fisc. e Part.I.V.A. 02224030466

DOMATIC[®]

DOMATIC
info@domatic.it www.domatic.it



fapim

BENELUX

Fapim Benelux s.p.r.l.b.v.b.a.
Avenue Rue St. Roch , 17
7712 Herseaux Belgium
T +32 56 340548
F +32 56 341960
info@fapimbenelux.be



fapim

HISPANIA

Fapim Hispania s.L.
C/edison, esq. A. Ingeniero
Goicoechea 45600
Parcela, 74
Talavera De la Reina (Espana)
T +34 925 828357
F +34 925 841148
administración@fapimhispania.com
pedidos@fapimhispania.com



fapim

POLSKA

Fapim Polska sp. z o.o.
ul.Przyrzeczce 4 03-107
WarszawaNIP : 536-16-29-437
T +48 227813797
F +48 227811022
Gsm 609022972



fapim

RUSSIA

Fapim RU Ilc
249010, Dom 33, Kievskoe Shosse,
Obninsk, Kaluga Region
Russian Federation
T +79 163116480



fapim

ARGENTINA

Fapim Argentina S.A.
Buschiazco N° 347
(1611) Don Torcuato
Partido de Tigre
Buenos Aires - Argentina
T +54 (11) 48463545